



16 November 2023

Flow Solutions Day

+ Safety instructions



 Notfall-Sammelplatz/
Emergency assembly point

 601
604 Zugehörige Gebäudenummer/
Related building number

→ Fluchtweg / Evacuation route Customer Experience Center

-  Aufmerksam sein/
Be attentive
-  Weisungen des GF-Personals
strikt befolgen/
Follow the instructions of the GF
staff strictly
-  Verlassen Sie Ihre Gruppe nicht/
Don't leave your group
-  Ausweis offen tragen/
Ensure your badge is visible
-  Vorsicht vor Staplerverkehr/
Beware of forklift traffic
-  Bitte berühren Sie nichts/
Please don't touch anything
-  Das Rauchen ist verboten/
No smoking
-  Das Fotografieren ist verboten/
No photos
-  Die persönliche Schutzausrüs-
tung ist gemäss den Anweisun-
gen zu tragen/
Wear the personal protective
equipment in accordance with the
instructions

Im Notfall / In emergency

-  Sanität: +41 52 631 3000
Emergency: +41 52 631 3000
-  Feuerwehr: +41 52 631 3000
Fire brigade: +41 52 631 3000
-  Im Notfall folgen Sie bitte dem
Fluchtweg...
In emergency, please follow the
evacuation route...
-  ... zum Sammelplatz
... to the emergency assembly point



**+ Photos,
videos and
streaming**



16 November 2023

Flow Solutions Day

Andreas Müller, CEO



Agenda

- | | | |
|---|---|---------------|
| 1 | Welcome and registration | 13:00 – 13:30 |
| 2 | Value creation rationale | 13:30 – 14:30 |
| | ▪ Q&A Session | 14:30 – 14:50 |
| 3 | Show cases – 2 groups | |
| | ▪ Building solutions deep dive | 15:00 – 15:40 |
| | ▪ Industry / Infrastructure deep dive | 15:50 – 16:30 |
| 4 | Wrap-up and Q&A Session | 16:40 – 17:10 |
| 5 | Aperitif | |
|  | Bus departures to Schaffhausen train station: | |
| | ▪ Bus 1: 17:30; Bus 2: 18:00; Bus 3: 18:30 | |





Presenters



Andreas Müller
CEO



Mads Joergensen
CFO



Joost Geginat
President
GF Piping Systems



Michael Rauterkus
President
GF Uponor



Going Forward, Moving Together

- GF rationale to become a **global leader in sustainable flow solutions**
- Introducing **GF Uponsor solutions** and management
- Deep dive into concrete **growth stories**
- Integration / **value creation program** and next steps

Note: No update on market and business environment





Value creation rationale



A major step for GF ...



New **Leader**
in **Flow Solutions**



Benefitting
from **Global**
(Sustainability) **Trends**

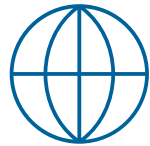

Strengthened
Portfolio and
global **Presence**



Advancing
sustainable and
innovative solutions



**Leading to a
more resilient GF**



... accelerating the GF Strategy 2025 ...

CHF 4.4 – 5.0 bn
Sales including acquisitions

9 – 11%
Return on sales

20 – 22%
Return on invested capital

Drive profitable growth
intelligent and sustainable solutions



Increase robustness
resilient portfolio and operational excellence



Evolve culture
performance and learning





... resulting in a strengthened portfolio and global presence

2022 sales
pro-forma

per division

per region
(pre-transaction)

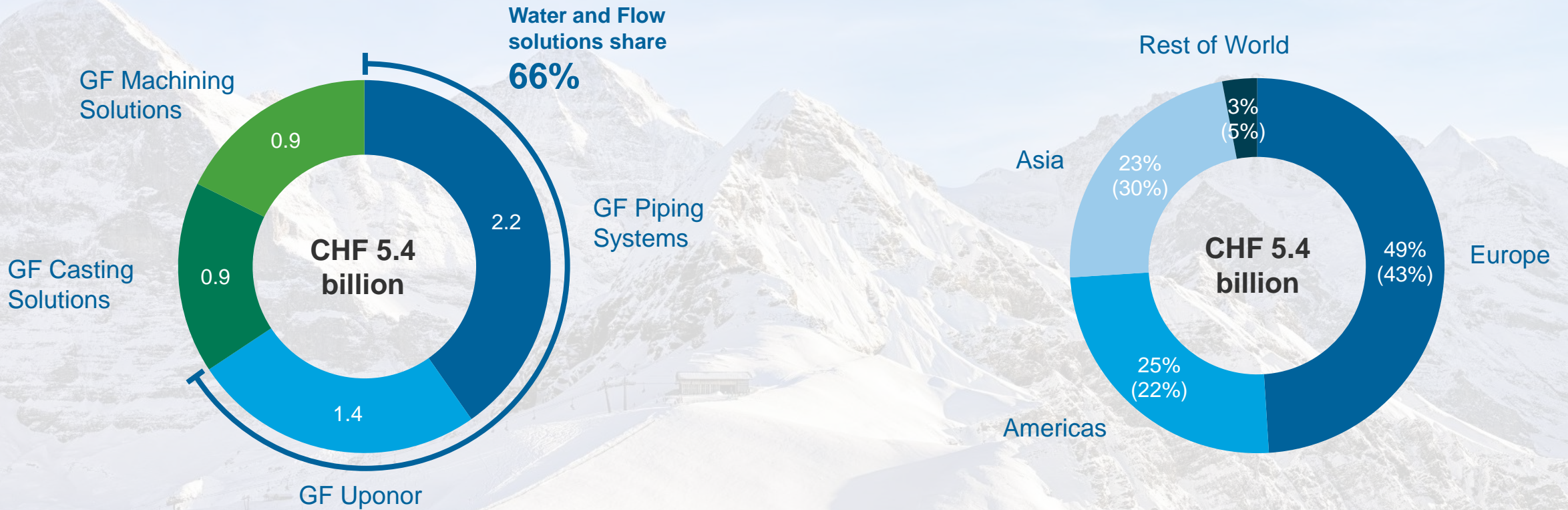



GF Piping Systems and GF Uponor are well positioned to benefit from global long-term trends ...

Energy efficiency in buildings



Energy transition



Urbanization



Digitalization





... and related demand for energy efficiency in buildings ...

Energy efficiency in buildings



~40% of EU energy consumption related to buildings
(75% not yet energy efficient)

~80% thereof, related to heating, cooling, and hot water

€ 560 bn Investment needs to meet EPBD, with 10 to 20% addressable market
until 2030

+GF+ uponor Complete product portfolio for indoor climate, hot & cold water and local distribution

EPBD: Energy performance of building directive
Source: Energy performance of buildings directive (europa.eu)



... for refurbishments and new urban infrastructure ...

Urbanization



+2.7 bn additional people to live in urban areas by 2050 compared to 2021

345 bn liters water lost by utilities every day at cost of \$39 billion a year

€ 700 bn Expenditure on water supply and sanitation **construction projects** in EU until 2030

+GF+ Complete solutions portfolio for **gas- / water distribution & storm- / waste water**
uponor

Source: United Nations Department of Economic and Social Affairs; Our World in Data – Urbanization; Roland Liemberger & Alan Wyatt



... supporting the energy transition ...

Energy transition



H2, Li Hydrogen and Lithium are key enablers to store renewable energy

€ 50 bn Green Hydrogen production in Europe

\$ 210 bn Li-Ion battery production extension in China

40 new Giga Factories 2020-2030 in Europe

+GF+ Strong product portfolio for industrial applications (certified)

Source: CIC Energygune, European Commission; Tech companies' announcements



... as well as the fast-growing digitalization

Digitalization



23% CAGR growth in data consumption in 2020-2025;
100 hyperscale data centers added per year

40% of energy needed for cooling of data centers

€ 600 bn investment in semi-conductor facilities by 2030 in Asia, US, and EU with increasing need for high-purity water

+GF+ Strong product portfolio for cooling and high purity applications (certified)

Source: Data centers | Statista



GF is catching up to become the leader ...

2022 peers overall and piping sales in EUR billion – pro-forma

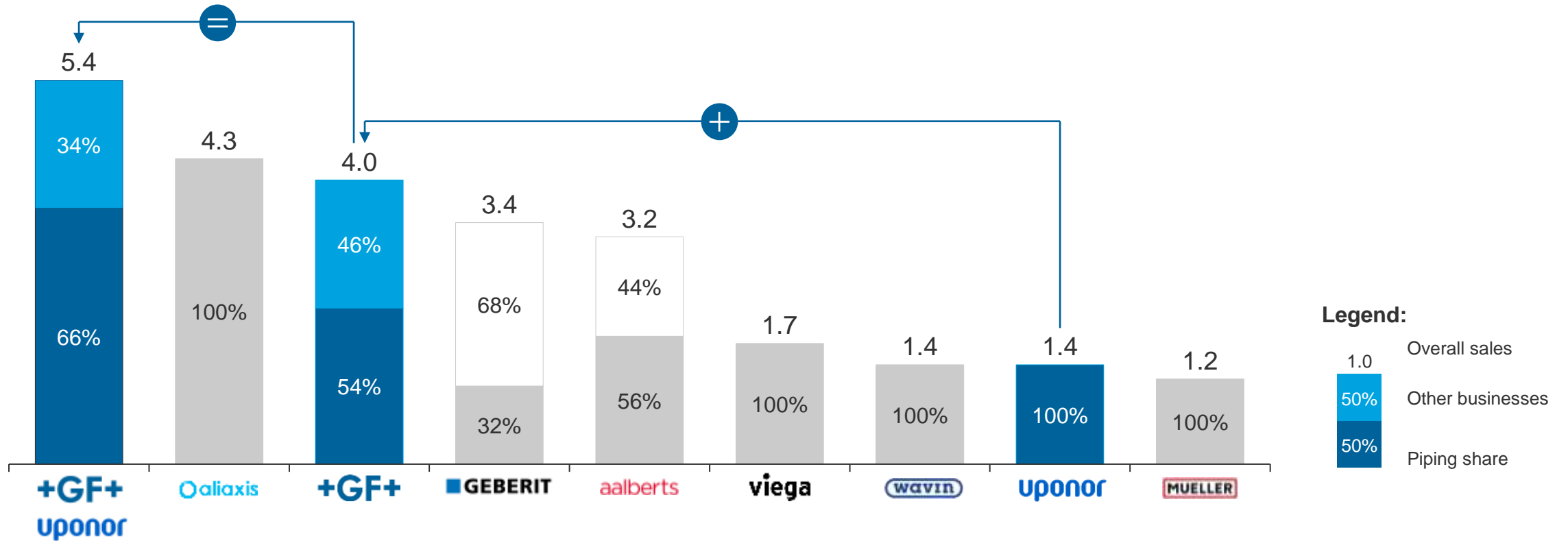

Source: Company information & filings; Geberit Piping: Piping Systems division; Aalberts Piping: Building Technology division; Wavin as of 2021A



... in resilient markets

2022 Sales by business segment (CHF million)

- GF Piping Systems (2022)
- GF Uponor

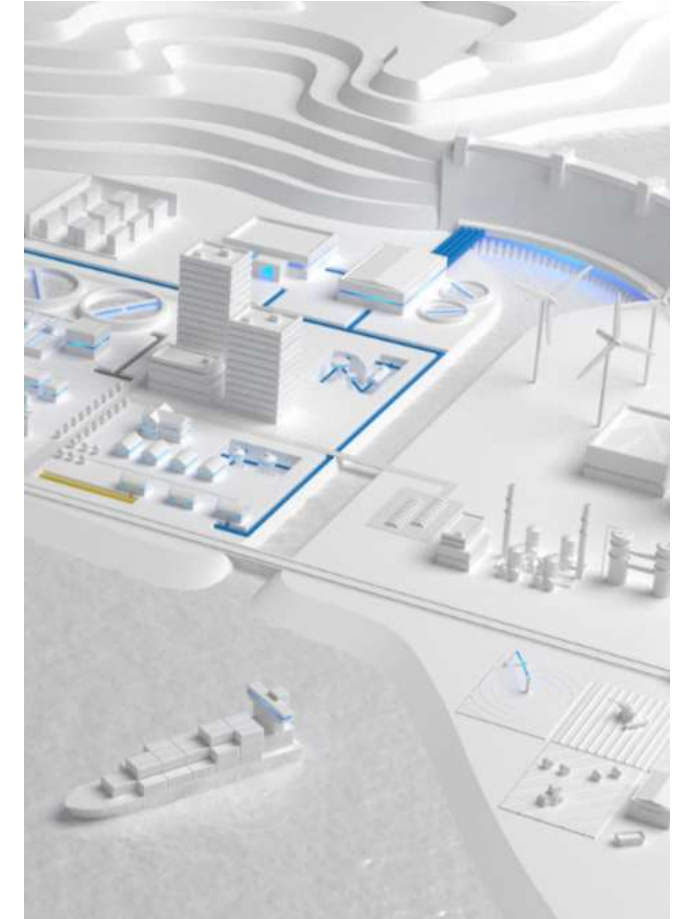
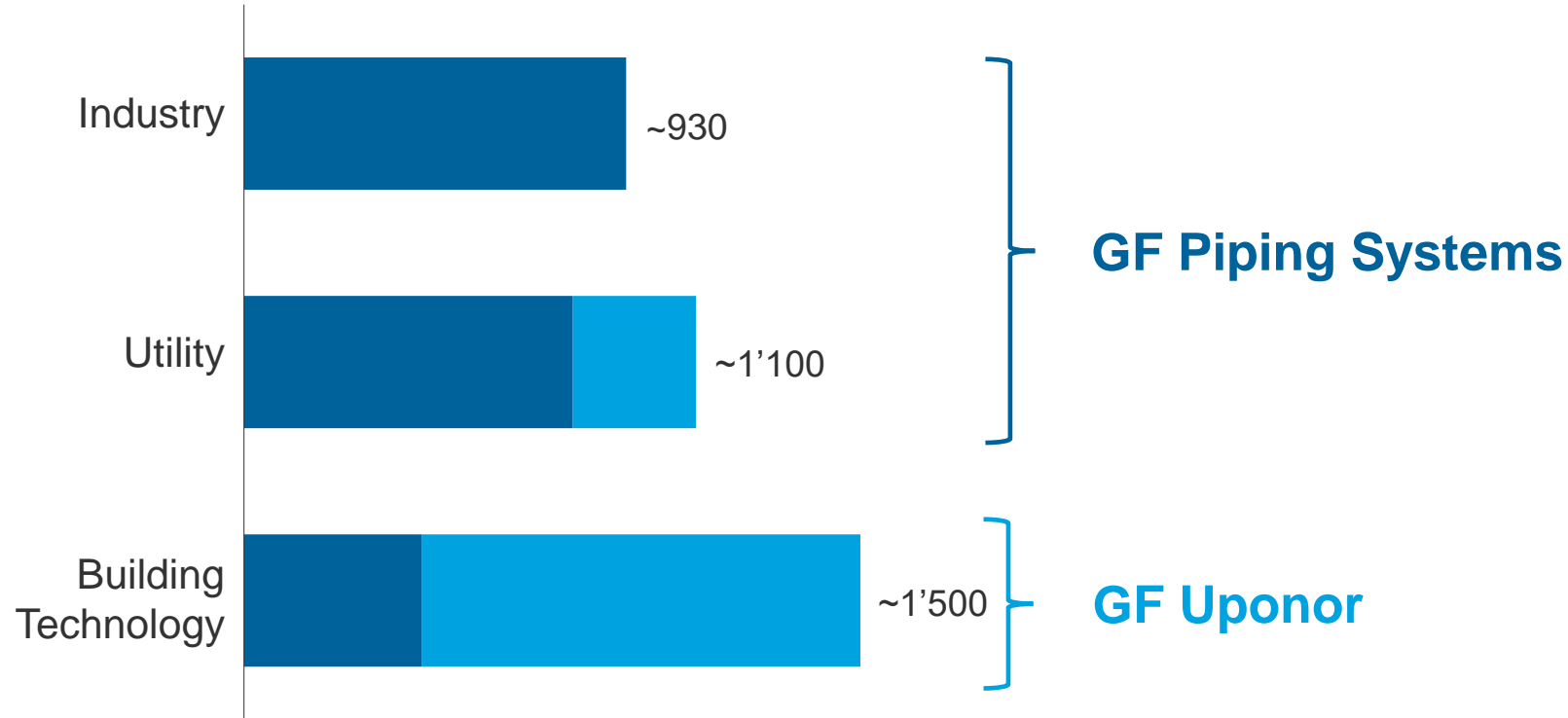



Our combined offering for building technology ...

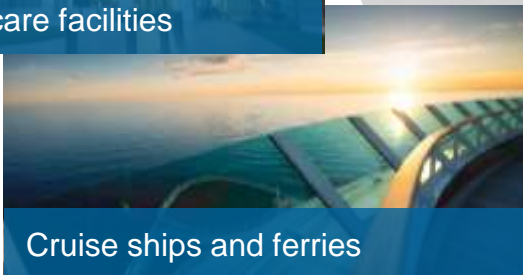
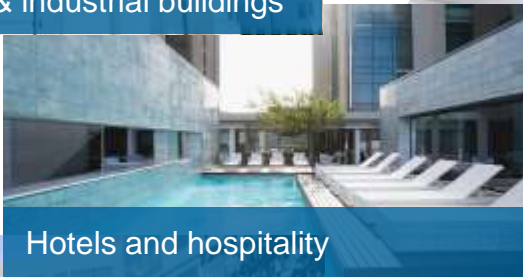



... is highly complementary across all applications ...



+ GF Uponor
Hot and cold-water distribution
Decentralized solutions

+ GF Piping Systems
Hyclean system, riser installations
Centralized solutions

Bathroom installation



... with significant leverage potential globally

Building Technology



Potential

- Switzerland
- Germany
- Nordics
- Middle East

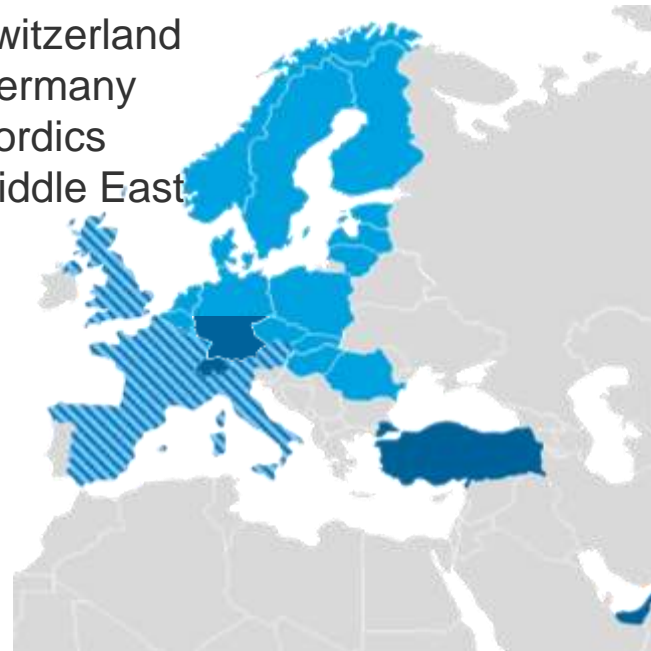

Presence

- GF Piping Systems
- GF Uponor
- GF Piping Systems & GF Uponor



Similarly, for utilities and infrastructure ...

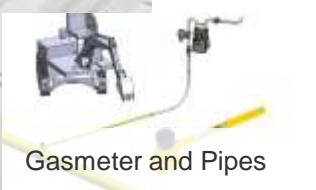
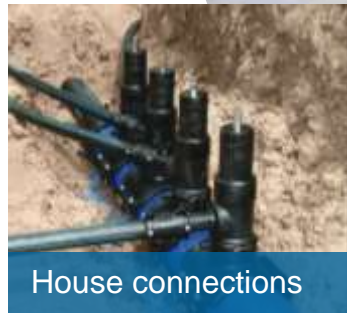



... together, we can offer comprehensive solutions ...

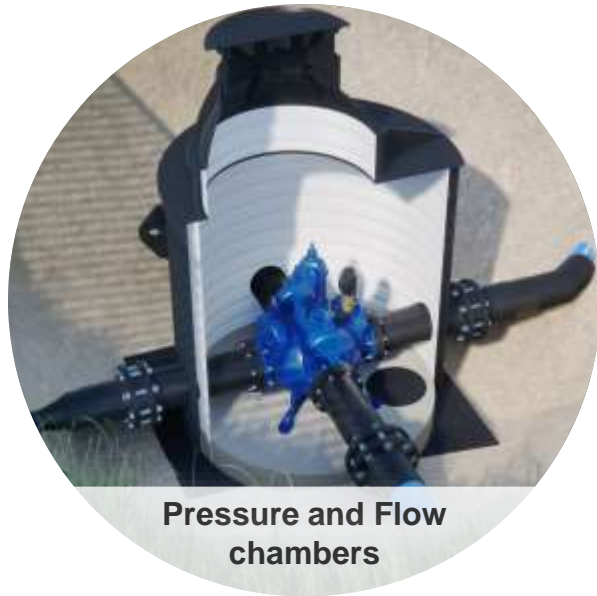

Pressure and Flow chambers



Prefabrication and Customization



Pressure Management

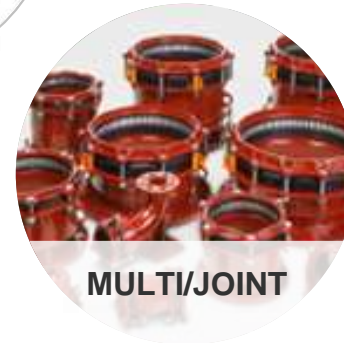

MULTI/JOINT



Water distribution



GF Uponor

Pressure and flow chambers



GF Piping Systems

Network performance and rehabilitation



... with potential to benefit from our global presence

Infrastructure / Utilities

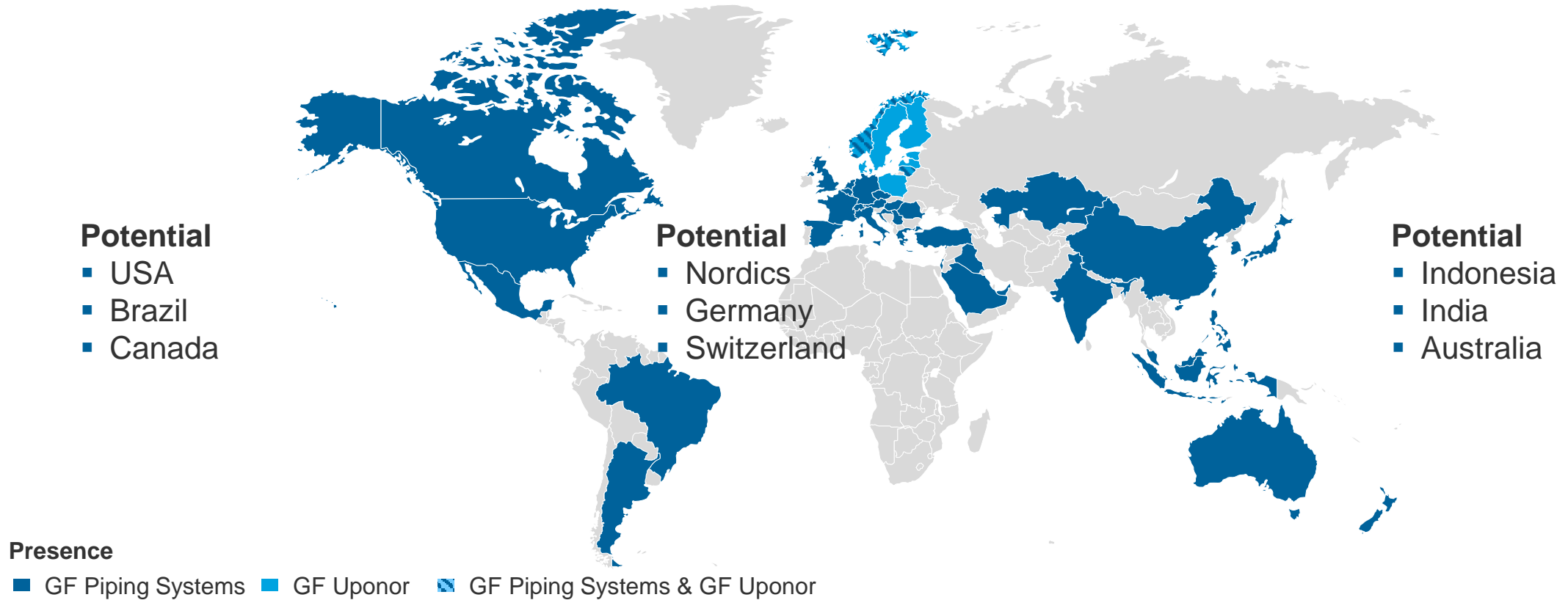



Not to forget – our strong industrial position



Food & Beverage



Chemical Process

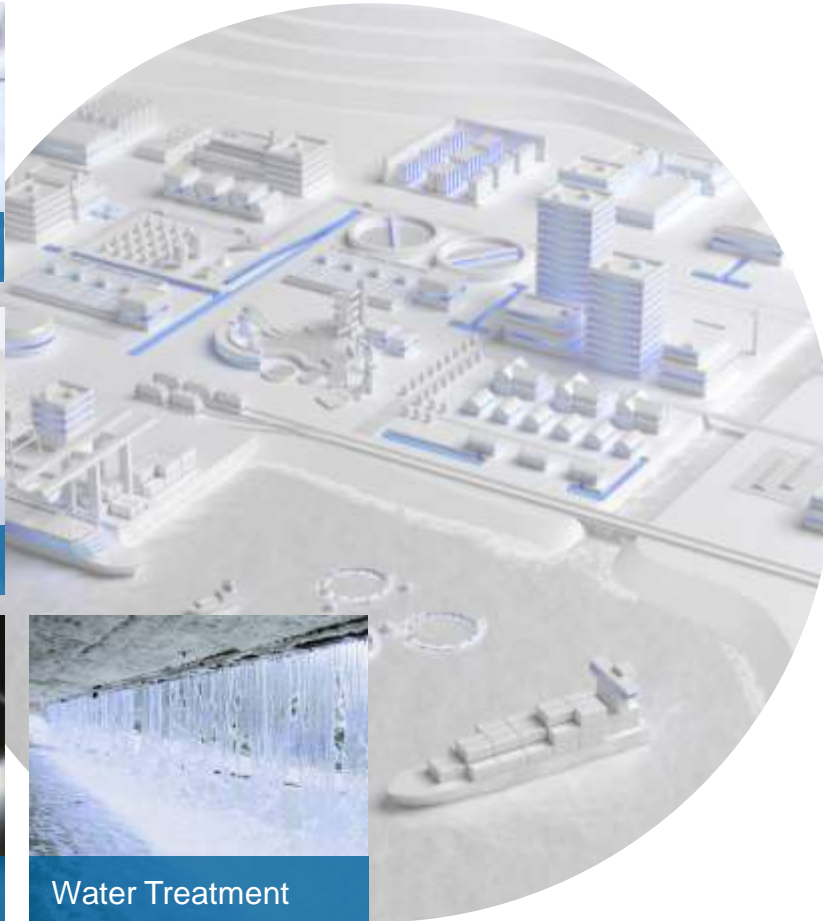

Battery Production



Marine

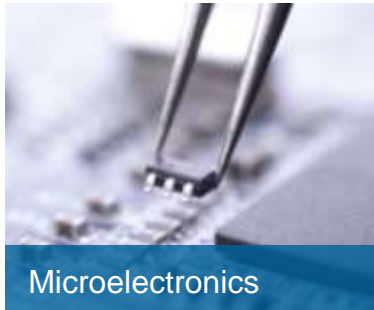

Microelectronics



Data Centers



Water Treatment



COOL-FIT



PVC



Valves



Flow sensors



Together, we can leverage our innovation power ...

36 innovations¹ launched since 2020 ...



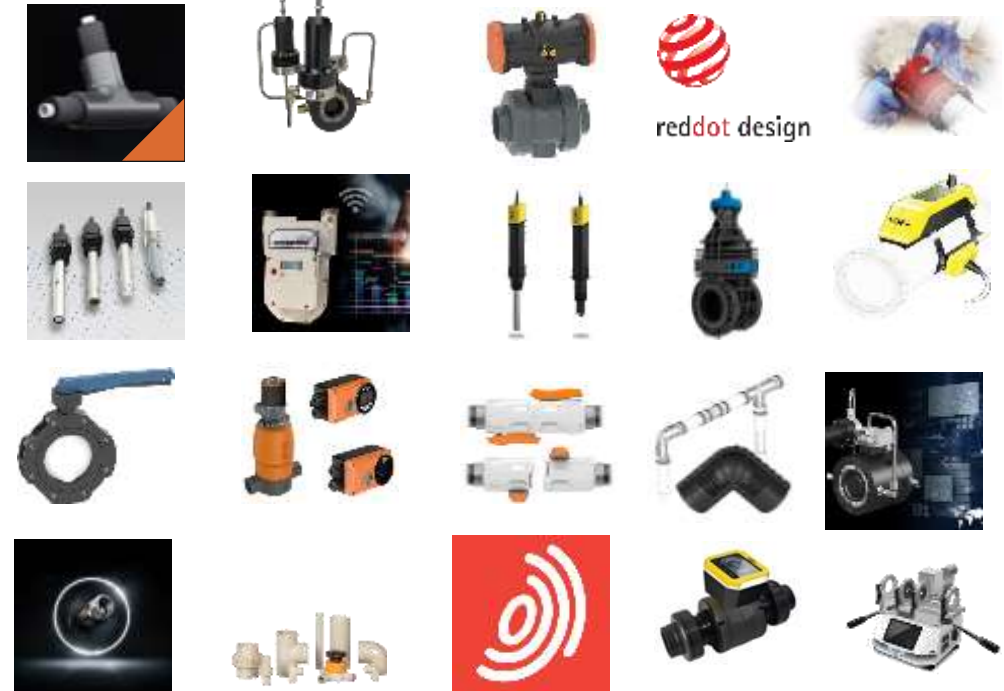

... and 35+ in the pipeline for launch until 2025



1: Only transformational and adjacent innovation projects considered (project classes 1 and 2)



... and strong commitment to sustainability and ESG

	+GF+	uponor
ecovadis	Gold (Top 1%) ¹	Gold (Top 6%)
 SUSTAINALYTICS	24th percentile In Machinery	7th percentile In Building Products
MSCI 	AA	<i>not rated</i>
 SCIENCE BASED TARGETS <small>DRAWING AMBITIOUS CORPORATE CLIMATE ACTION</small>	Successfully validated Targets for greenhouse gases reduction	Successfully validated Targets for greenhouse gases reduction & net zero



Source: Company information, Sustainalytics, CDP, ISS and Ecovadis; 1 In the manufacture of plastic products



Going Forward, Moving Together – with significant benefits

Cross selling

- Products & Solutions Portfolio
- Channel Leverage
- Global Penetration

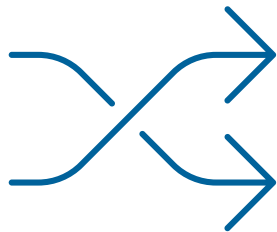

Technology leverage

- Combined Innovation pipeline
- Optimized Production Footprint
- Sustainability focus

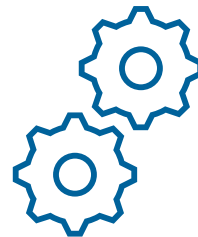

Working together

- Best use of Brands
- Procurement Power
- Shared Services
- Best Practice Sharing





GF Uponor overview



An international brand with strong innovation heritage

The first plastic factory, Upo-Muovi starts in Nastola, Finland



Uponor introduces the unique structured wall pipe construction called Ultra Rib



First overlapped welded multi-layer composite pipe (MLCP) is invented and patented



The world's first press fitting for MLCP is launched



Uponor consolidates all business under one brand



Circular PEX pipe produced from own PEX production waste



First in the industry with SBTi approved net-zero target

1918

1965

1972

1986

1988

1990

1991

1993

1994

2006

2022

2023



Aukusti Asko-Avonius establishes a carpentry workshop in Lahti, Finland



The world's first PEX pipes produced in Wirsbo, Sweden



Plastic hot water pipe business Hewing in Germany and Wirsbo in Sweden acquired



Wirsbo opens a factory in Apple Valley, Minnesota, USA



Launch of the unique and revolutionary Quick & Easy fitting system



Uponor launches world's first PEX Pipe based on renewable raw materials



GF Uponor is an industry leader with an attractive geographic and end-market exposure ...

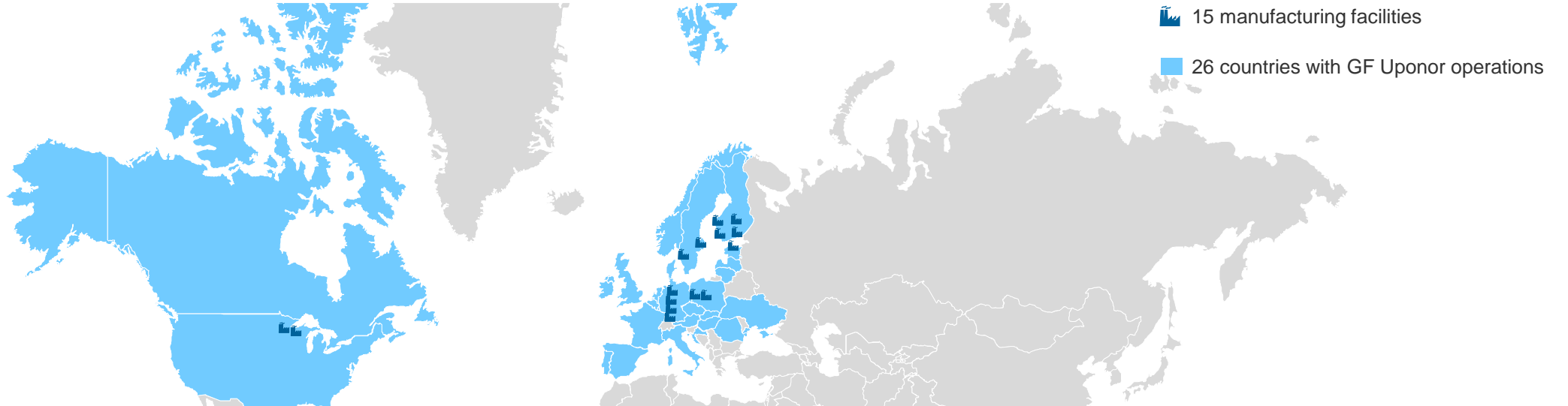

Key Figures 2022

€1.4 Billion net sales

Balanced divisional mix

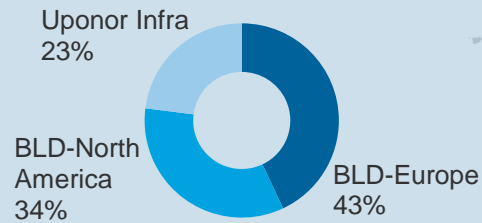

3'600 Employees (9/2023)

Attractive end-market exposure

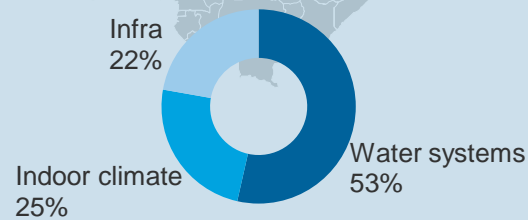

~80 Countries where our products are sold

Balanced geographical exposure

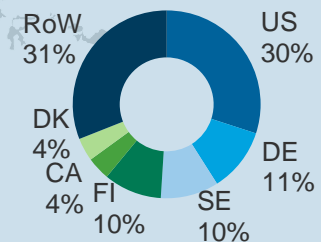



... with a comprehensive product and applications portfolio for buildings...





... and reliable solutions for infrastructure





Achieving strong profitability performance ...

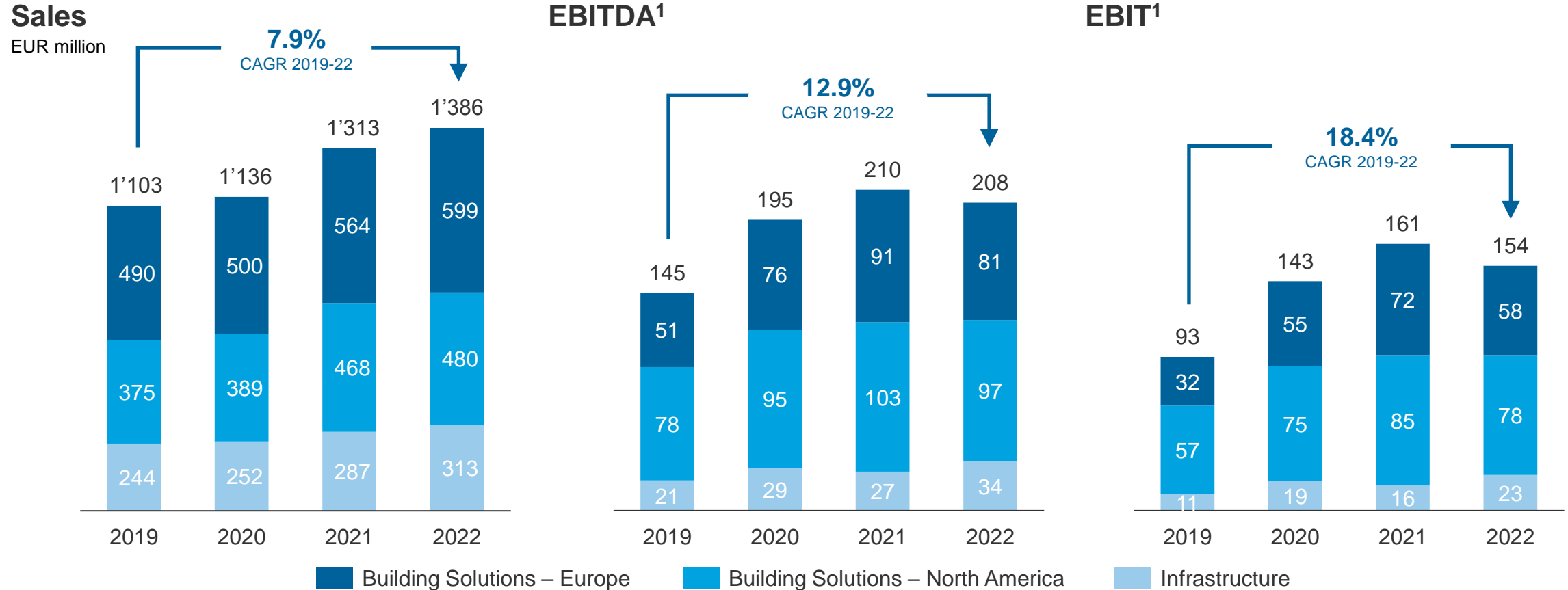

Source: Company information | 1 Based on Uponor's comparable operating profit. Segmental comparable operating profit and comparable EBITDA are before 'Others' and 'Eliminations' as per segment reporting



... expected also for 2023 based on Q3 results

	Net sales	Comparable operating profit	Comparable OP margin	Highlights
Q3	-18.0% 298.5 M € (364.0)	-19.7% 36.1 M € (44.9)	12.1% (12.3)	<ul style="list-style-type: none">Strong comparable OP margin despite soft overall market demandAdjusted for structural changes, Q3 net sales -14.7% and YTD -12.4%Strong profit performance in Building Solutions – North America and Uponor InfraTransformation program on track
YTD Sep	-15.0% 943.4 M € (1,109.7)	-13.8% 122.9 M € (142.6)	13.0% (12.9)	



GF Uponor's strategy is well under way

Unlocking the potential
of water to protect the place we call home

To be the leader in sustainable water solutions



Max the Core

Country, Customer, Category
and Channel



Innovation

Innovation of sustainable
solutions and integrated systems



Sustainability

Lead construction industry
towards net zero



People First

Instill performance
mindset

Transformation to new Operating Model

Create lean and resilient organization
Enhance and harmonize business processes and systems



Transformation on track towards a leaner and more resilient GF Uponor...

Savings from the Transformation Program ...

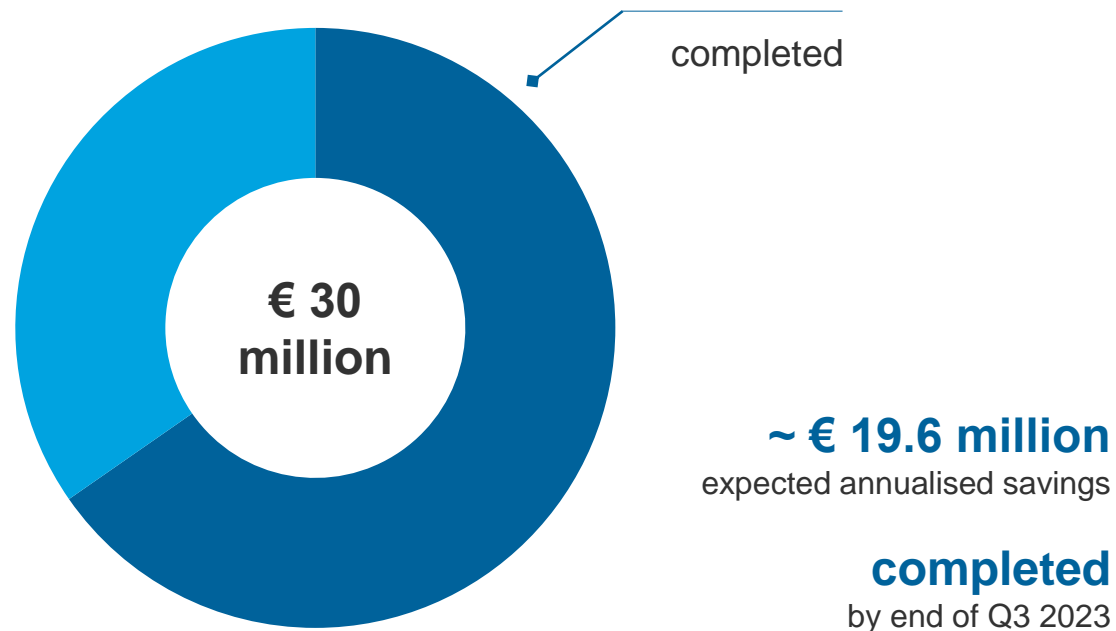

... and related headcount reduction

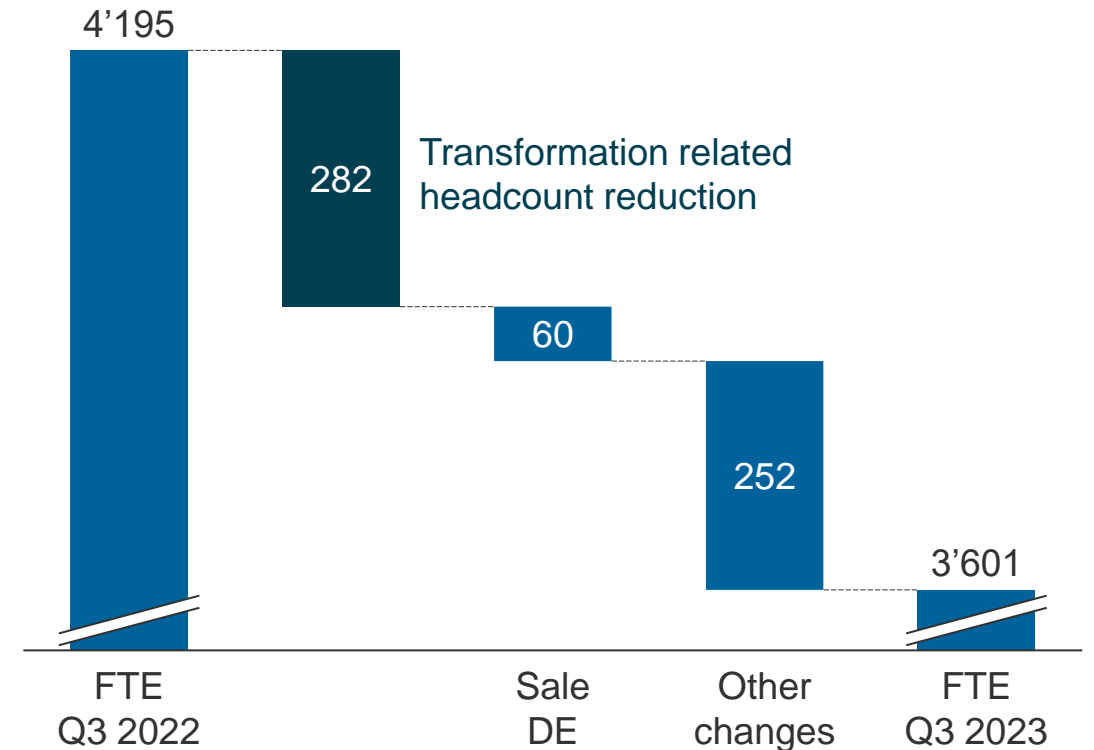



... with improving operational excellence and accelerating innovation pace



Step-change in safety

Improvement in Lost Time Injury Frequency

LTIF 68%



Improved service

On-time delivery

OTD +32%
(Building Europe Division)

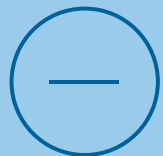

Less complexity

Reduction in

SKUs 52%
(Building Europe Division)



Accelerated innovation

New Innovation

Projects 5x



Strategy execution and innovation to accelerate further with GF

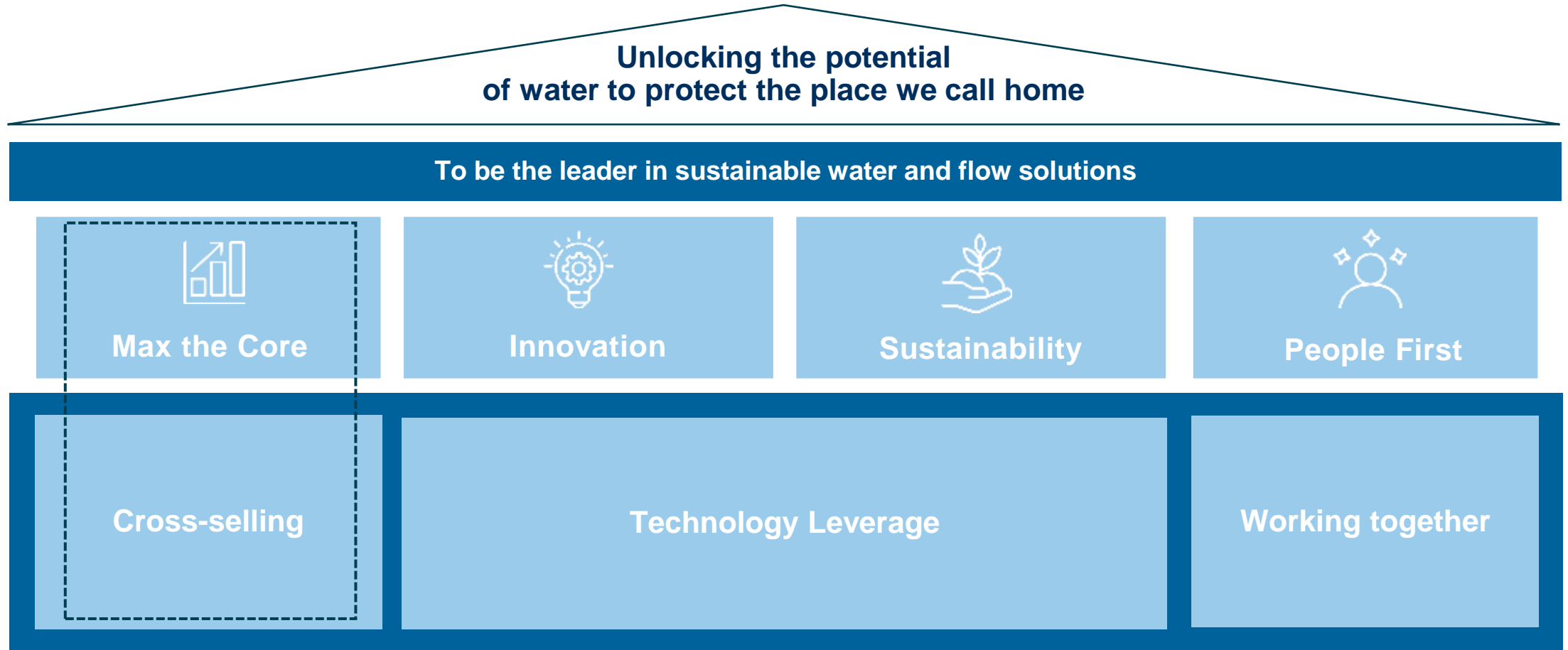



Going from two separate portfolios of systems ...

Plumbing and Water systems

+GF+ uponor

Plumbing and Indoor Climate systems





... towards complete solutions for both water delivery and indoor climate

+GF+ uponor

Plumbing and Water Solution

Indoor Climate Solution

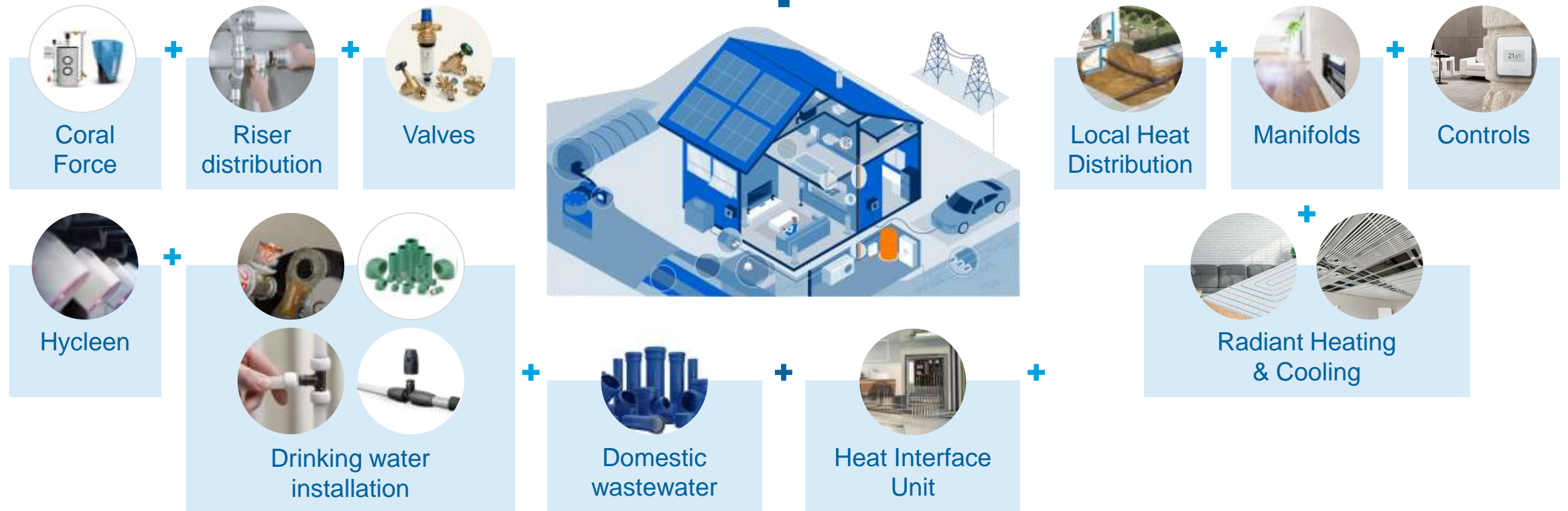



Our sustainability work has a legacy of industry firsts – now also SBTi validation for net-zero target





Value Creation Program



Acquisition of a high-quality business at an attractive multiple

Offer consideration

FY22 EV / EBITDA¹

Financing

<p>EUR 2.2 billion Enterprise Value</p>	<p>10.6x Headline multiple</p>	<p>Excess cash and committed bridge / term loan from UBS / ZKB</p>
<p>93.8% Threshold 50% + 1</p>	<p>8.9x Post-synergy multiple²</p>	<p>8 million GF shares intended to be issued from existing capital band (<10% of shares registered)</p>
<p>Notes: Foreign exchange rates of EURCHF 0.985 as of 31-Dec-2022 and of EURCHF 0.975 as of Jun-2023 1 Based on Uponor's comparable operating profit plus D&A; 2 Including run-rate synergies of EUR35-45 million 3 Based on existing accounting principles</p>	<p>EPS accretive Expected from first full year of consolidation³</p>	<p>< 2.25x Leverage post equity increase Commitment to prudent capital structure; no change in existing dividend policy</p>



... enabling synergies of EUR 35-45 million p.a. at full run rate in 2027

Sales synergies

- **Cross-selling** in common markets leveraging mutual go to market
- **Full penetration** of GF Uponor in **Switzerland's** and other markets
- **Full expansion** of GF in the **Nordics** Industry and Utility
- Acceleration of **GF Uponor's North American strategy**
- **Innovation** boosted & leveraged on much **larger scale**

Cost synergies

- **Operational excellence** – exchanging mutual best practices
- Optimization of operational footprint
- Set-up of a global **procurement** and other shared services

- Equal potential of sales and cost synergies
- Sales synergies with longer ramp up time
- Main portion of synergies realized in 2025 onwards
- CHF 25-30 million one-off costs expected until 2027



Strategic aspirations well aligned – update on combined ambitions in Q1 2024

Published strategic targets

GF
2021 - 2025

GF Piping Systems
2021 - 2025

Uponor
2022 - 2024

Uponor
2025ff

Growth rate
organic CAGR

3-5 %

4-6 %

>4 %

Ambition to further
accelerate growth
rate

EBIT margin

9-11 %

13-15 %

>12 %

Ambition to further
increase
OP-margin

ROIC

20-22 %

20-24 %



The value creation program is set-up and kicked-off ...

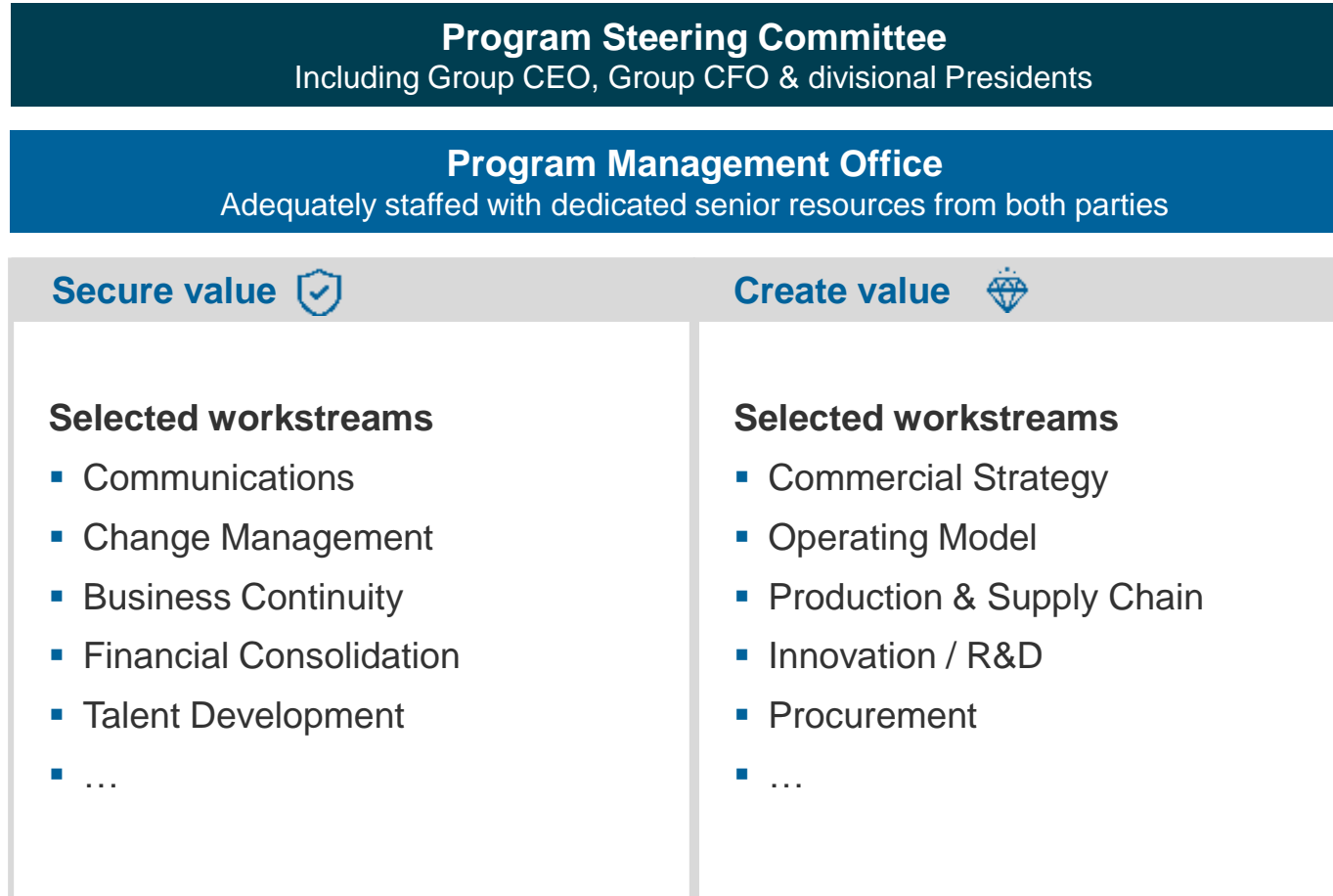

Timeline

- Pre-Day 1
 - Preparation
 - Day 1 value protection taskforce
- 13 November **Day 1**
 - Onboarding
- Until H1 2024
 - Direction setting
 - Detailed planning
- Mid-2024 onwards
 - Implementation
 - Value capture



Outlook and next steps

19 March, 2024*

Publication of Annual report 2023 including a full consolidation of Uponor Oyj

* Date adjusted as published on 1. November 2023

17 April, 2024

Annual General Meeting 2024

H1 2024

De-listing of Uponor Oyj at NASDAQ FIN

18 July, 2024

Publication of Mid-year report 2024

2025

Announcement of Strategy 2030



+ Q&A

An aerial photograph of a river with a prominent white water rapids section. The water is a deep blue-green color, and the rapids are a bright white. The river flows from the top left towards the bottom right. A semi-transparent white banner is overlaid across the middle of the image, containing the text 'Show cases'.

Show cases



Presenters in show cases

Building Technology deep dive



Michael Rauterkus
President
GF Uponor



Andres Caballero
President Building Division NA
GF Uponor



Mario Hegi
MD Switzerland / International
GF Piping Systems

Industry / Utility deep dive



Joost Geginat
President
GF Piping Systems



Sebastian Bondestam
President Infra Division
GF Uponor

Split in 2 groups for show cases outside Auditorium



Industry & Infrastructure Show Cases



Global Executive Management Team



Joost Geginat
President

Joined 2016



AlixPartners
Roland Berger



James Jackson
BU Americas

Joined 1999



+GF+



Jens Frisenborg
BU Industry/Utility

Joined 2000



SIEMENS
HILTI



Thomas Hary
Finance/IT

Joined 2005



+GF+



Michael Toh
BU Asia

Joined 2018



Honeywell
Johnson Controls
NISSAN
ABB



Christopher Duhnen
BU Building Technology

Joined 2020



xylem
SCHULER
Linde
FREUDENBERG
INNOVATING TOGETHER



Noel Schreiber
HR

Joined 2007



Webasto



Dominique van Ackere
BU EMEA

Joined 1989



+GF+



We make piping systems. But it's much more than that





We offer leak-free piping solutions for numerous demanding end markets

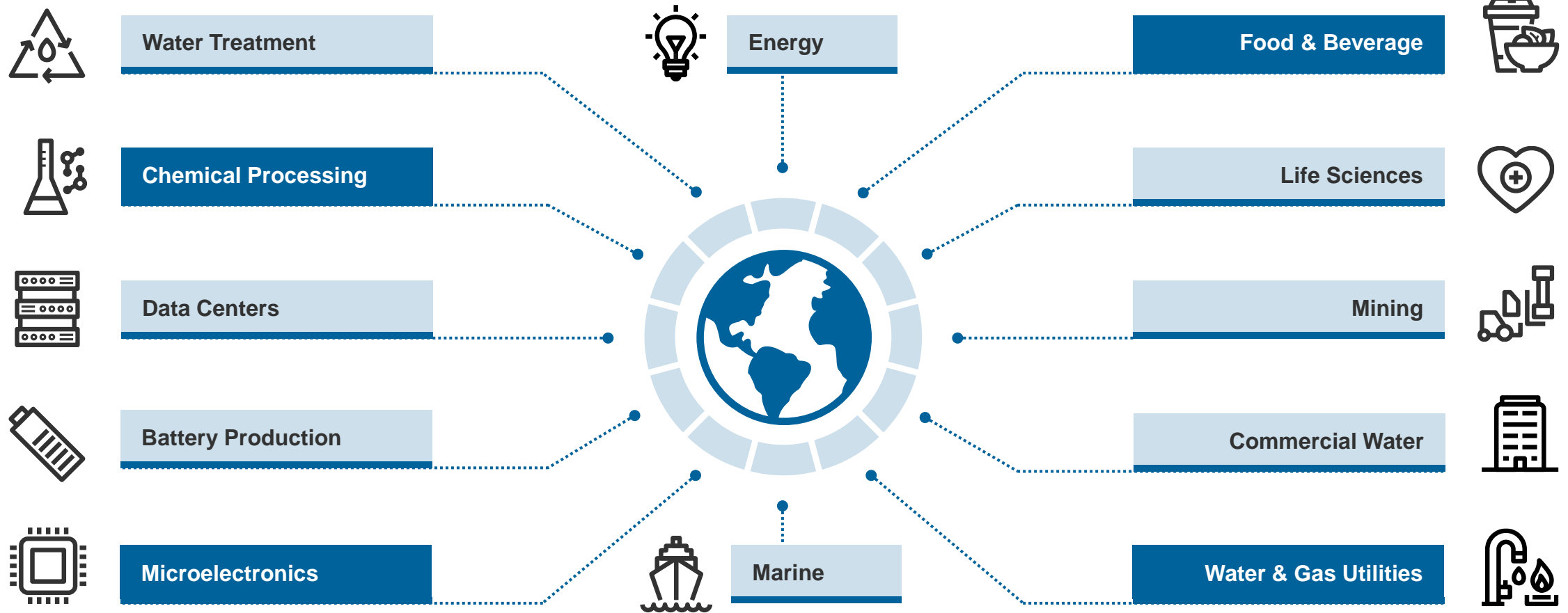



Water intensity in the semiconductor industry



The semiconductor industry has an increasing demand for high-quality water

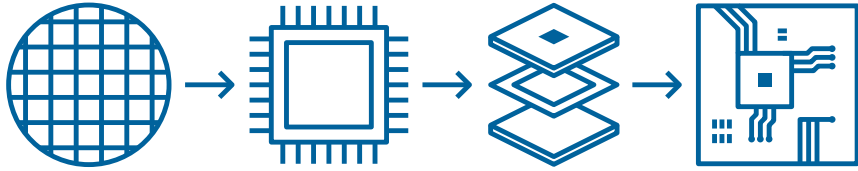

An individual fab consumes **tens of millions of gallons of water per day**

Water supply challenges for the semiconductor industry

Chris Jones, Oct 2022

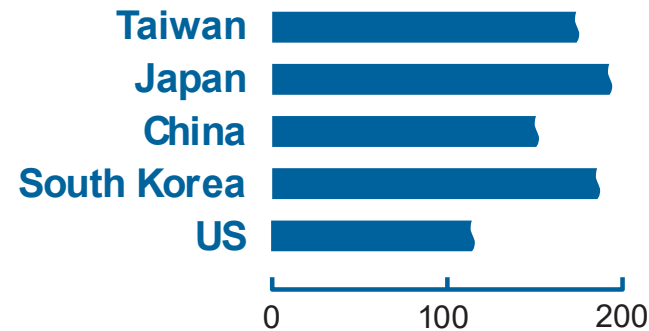

Annual Feedwater Withdrawal (Billions of liters)
Water Resources and Industry (2019)

+ 40% increase

Rising water demand
By 2030, water demand will exceed supply by 40 percent. GF Piping Systems can help improve water quality and reuse.

Ultra system confidence. Mission-critical water cycle solutions. Find out more at:

gfps.com/microelectronics

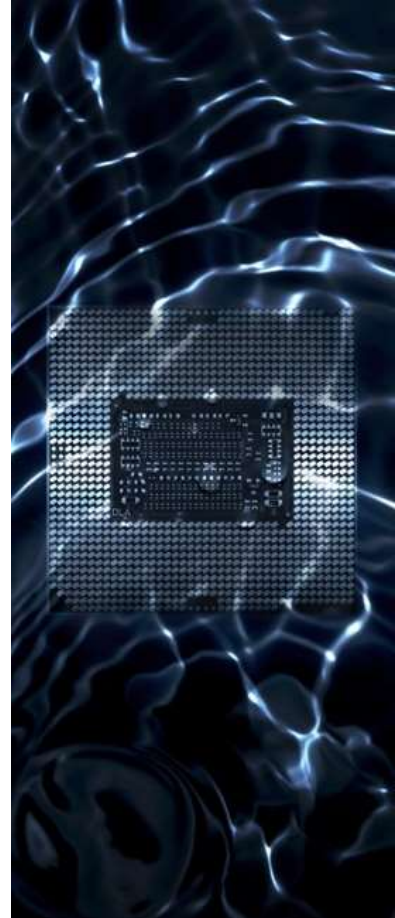



Our application know-how ensures we meet the mission-critical water process needs of our customers

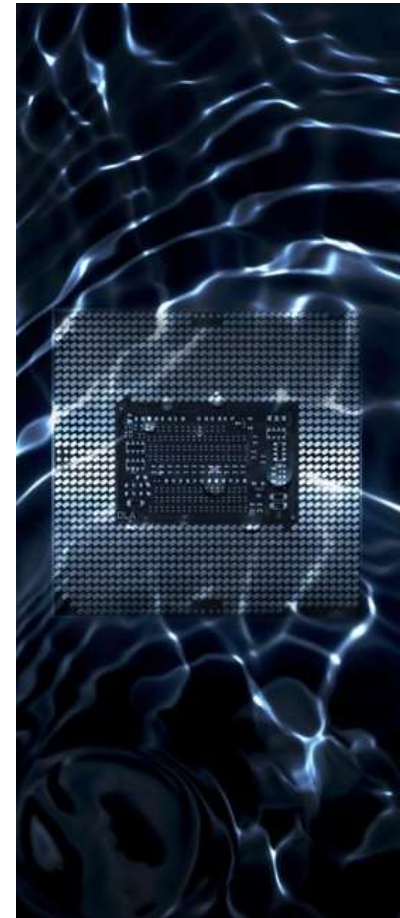
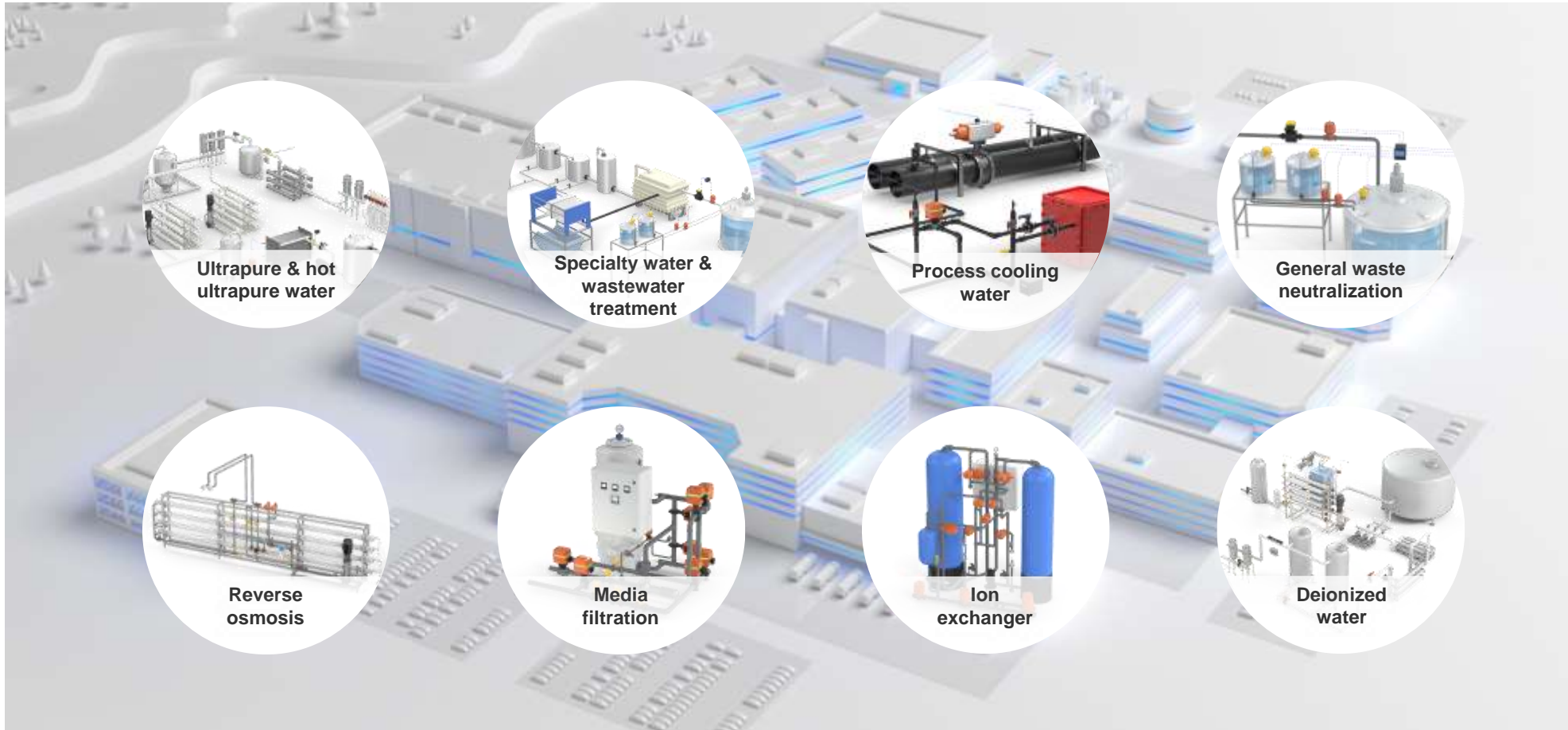



USD ~600 bn of projects announced globally and construction is planned over the coming years

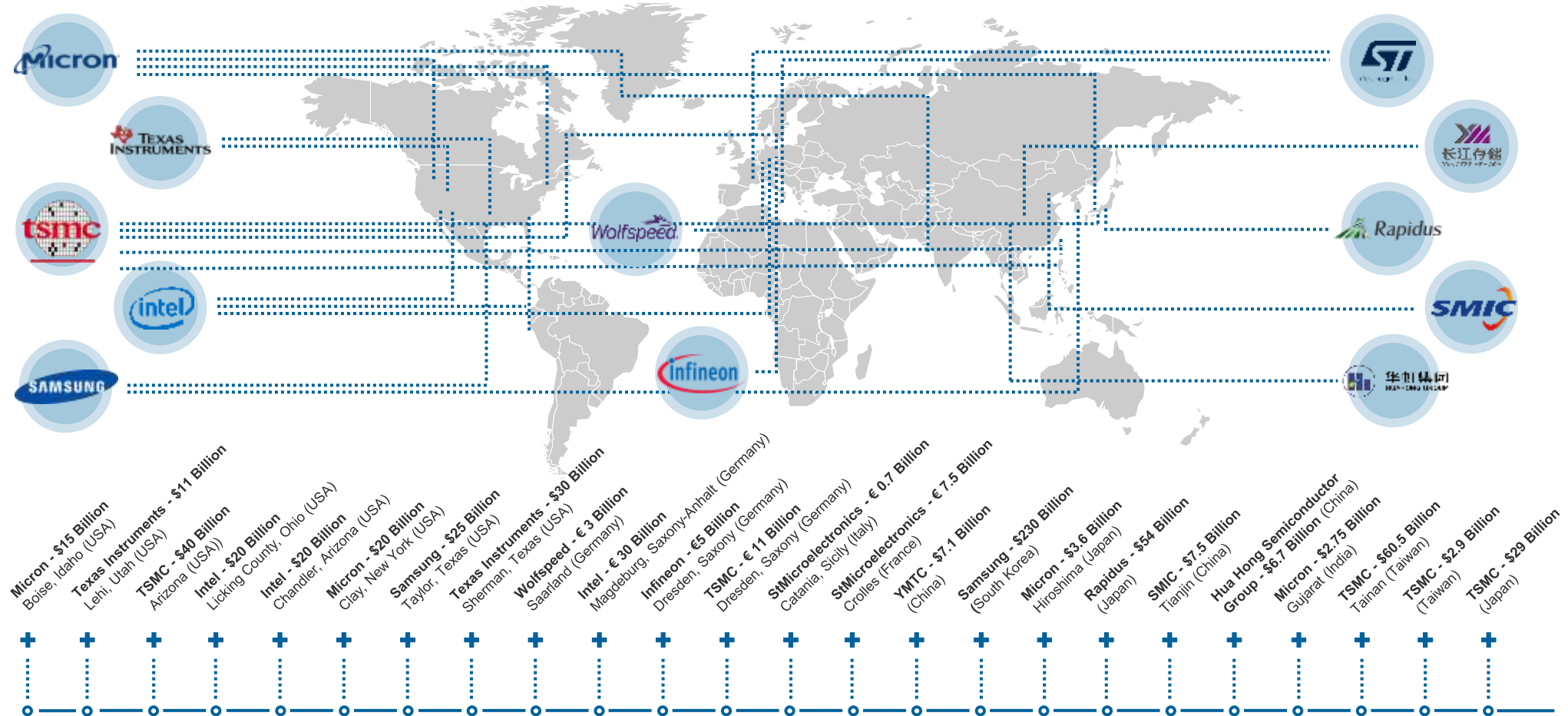

Source: GF Analysis

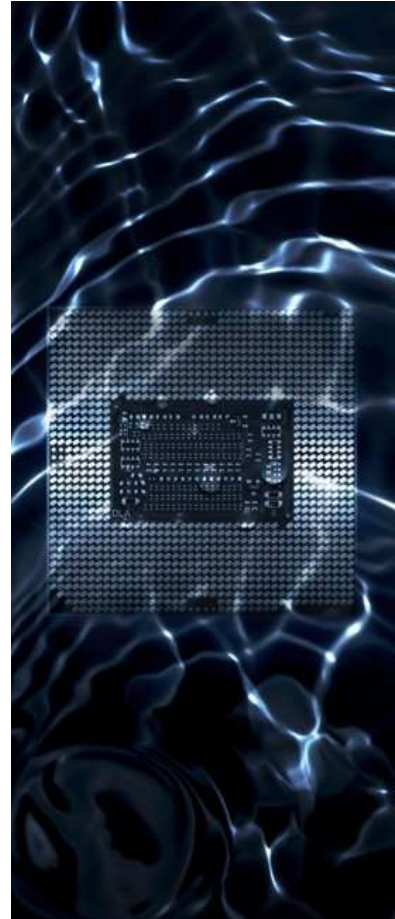



From design through to operation, we support the entire fab construction process and beyond



Advanced engineering services
We support engineering and design at the front end of a project



Off-site manufacturing, channel sales, and installation training
We prefabricate systems and modules in our 17 OSM hubs and deliver them directly to construction sites



Lifecycle support
We partner with OEMs throughout a fab's lifetime

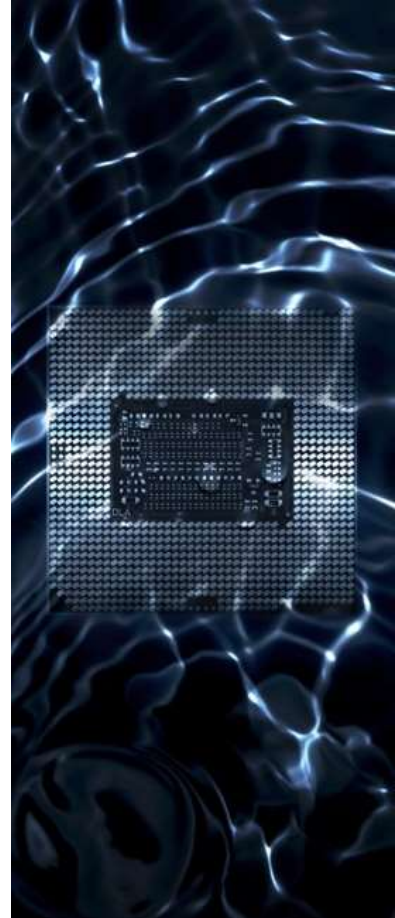
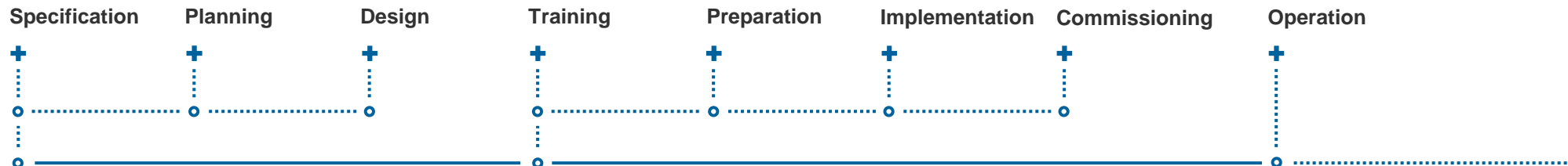



We are a partner for life, right there alongside our customers as we build a better tomorrow



GF Piping Systems is **one of only 22 Distinguished Supplier Award recipients** across Intel's global supply chain



GF Piping Systems is also **one of only 18 Excellent Performance award recipients** across TSMC's global supply chain.



+30 years Supporting the industry's efforts to build the most sustainably managed fabrication factories

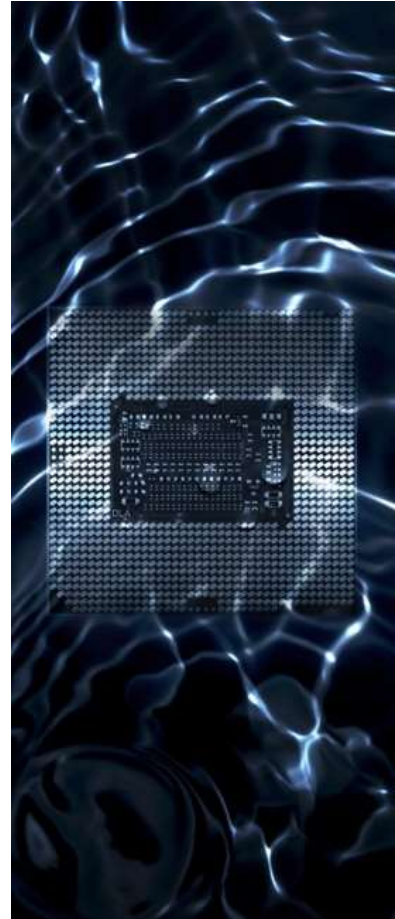



Automated flow control for cost-efficient chemical processes



Across multiple segments, the demand for process automation technology is increasing

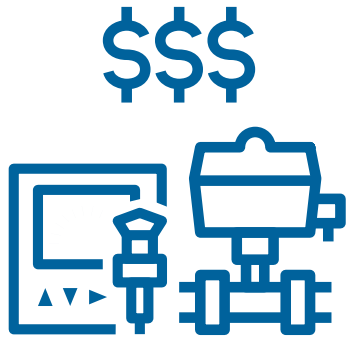

Serviceable
Process Automation
market worth
USD 6-7 billion

Source:
Allied Market Research,
MarketsandMarkets, Global Water
Intelligence, Expert interviews, GF Analysis

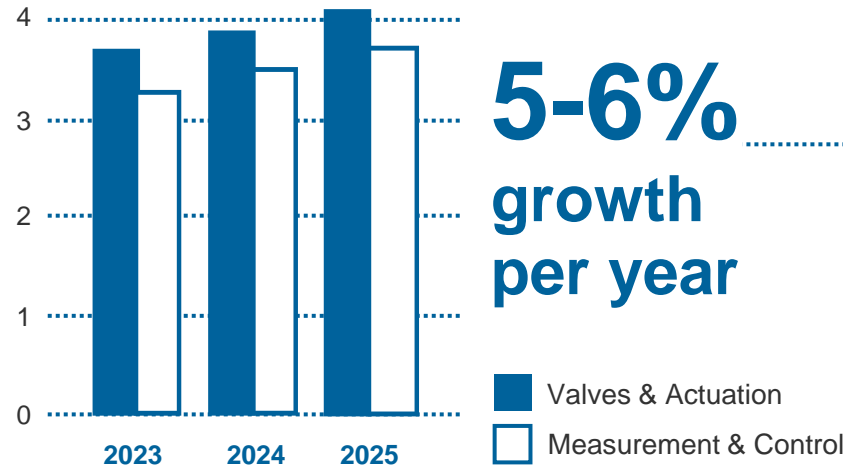

Total market for water and wastewater treatment applications, including process water and wet chemical distribution (USD bn)

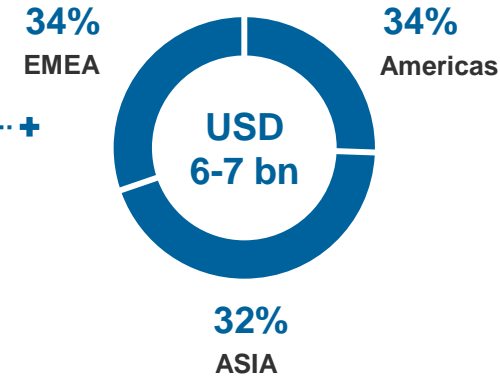

We offer a true partnership with a unified vision towards active water conservation. Find out more at:

gfps.com/processautomation





Here's an example of how we're already helping to improve water quality and reuse worldwide



In partnership with Tianjin OMZ, we helped our customer to produce L-lactic acid for different industries. L-lactic acid serves as a key raw material for biodegradable products.

+ **50'000+**
tons per annum



Operations began in Spring 2022 with pneumatic diaphragm, ball valves, and a significant number of manual valves across seven ion exchange systems.

+ **5'000+**
valves



Reduction in wastewater discharge thanks to the separation process reducing acid and alkali water. Additionally, construction times were shortened.

+ **40%**
reduction





And with Uponor Infra, we open up further opportunities within the aquaculture segment

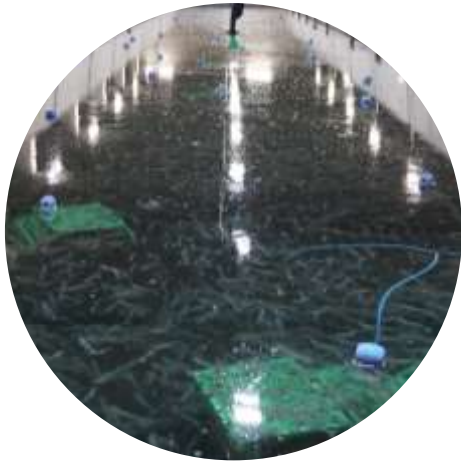

For land-based farming, the estimated CAPEX is 10-fold compared to conventional marine-based production.

+ **7% CAGR**
Inland water aquaculture*



Intake and outfall pipeline systems for a land-based fish farm from Uponor Infra enable fish to be produced closer to markets

+ **€ ~90 bn**
investment by 2030**

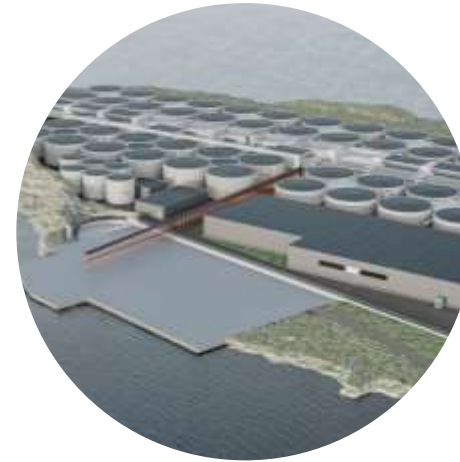

Aquaculture recirculating systems (RAS) differentiate in waste emissions and infrastructure needs

+ **20-35% CAPEX**
investment in RAS**



Source: *State of World Fisheries and Aquaculture – Food and Agriculture Organization of the UN (FAO) 2022 ** Global Water Intelligence



Water utility network rehabilitation and performance



Water scarcity requires network rehabilitation and performance improvements

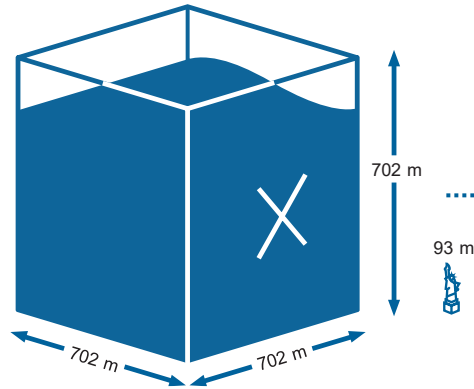
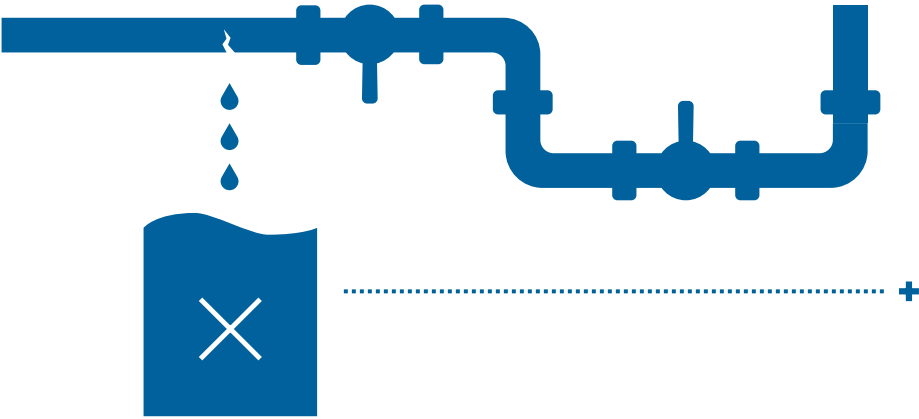

+ This amount of lost water could supply **more than half of the world's population**

Water utilities lose **345 billion liters of water every day** at the cost of \$ 39 billion a year

Water lost per day

We want to tackle water loss by solving critical water and infrastructure challenges. Find out more at:

gfps.com/solving-water-loss

Quantifying the global non-revenue water problem
Roland Liemberger & Alan Wyatt

According to the United Nations General Assembly, Every human has the right to access between **50 and 100 liters** per person per day.





Together, we can help solve this issue and further position ourselves as a utility and infra leader ...

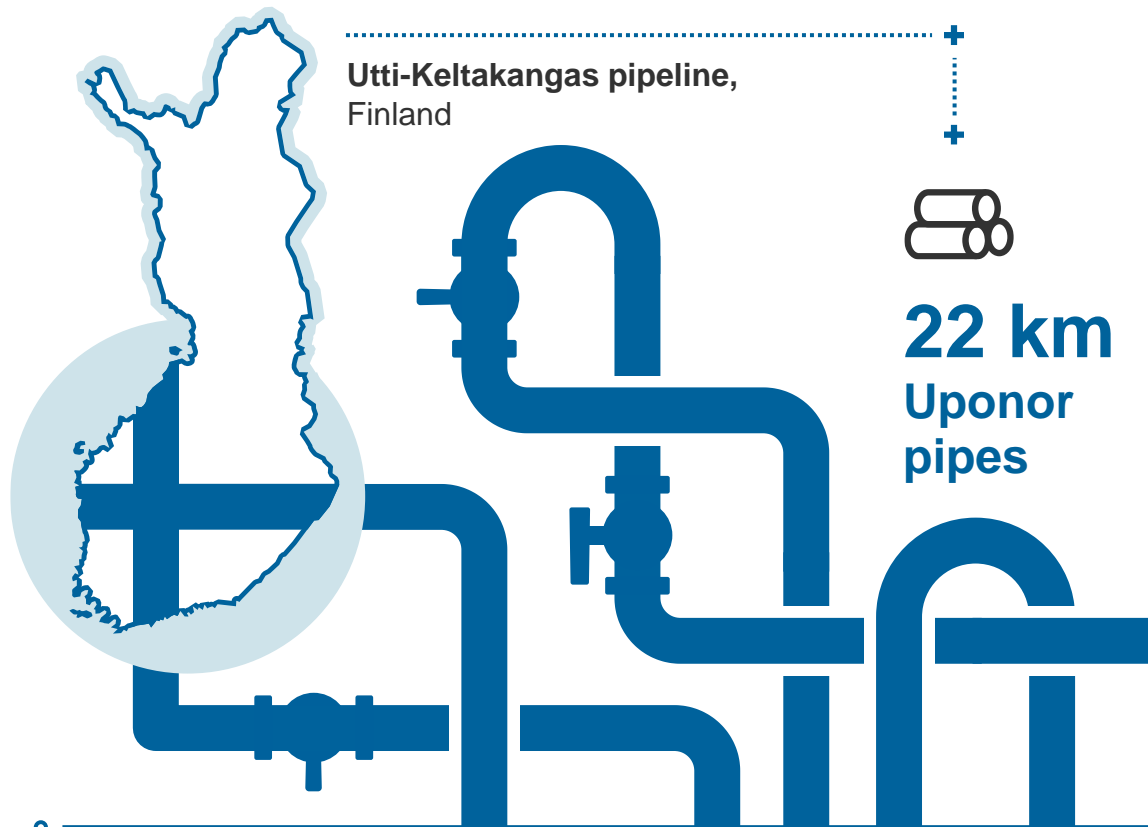

+GF+
290 ELGEF Plus
Couplers



+GF+
56 ELGEF Plus
Saddles



Leading provider of utility and infrastructure solutions in the Nordics based on sales of pressurized and non-pressurized GF Piping Systems utility and Uponor Infra portfolio





... and open up further opportunities due to ready-made synergies such as pressure management



Pressure and Flow chambers



Prefabrication and Customization



Pressure Management



MULTI/JOINT



+ **GF Uponor**
Pressure and flow chambers

+ **GF Piping Systems**
Network performance and rehabilitation



Our expanded portfolio helps address the challenges for water and gas utilities worldwide





+GF+ uponor



Building Flow Solutions Show Cases



GF Uponor Leadership Team



Michael Rauterkus
President and CEO



Joined 2021



Andres Caballero
President, Building Solutions
– North America



Joined 2022



Sebastian Bondestam
President, Uponor Infra



Joined 2007



Markus Melkko
Chief Financial Officer



Joined 2022



Thomas Fuhr
Chief Technology Officer



Joined 2022



Jennifer Hauschildt
Chief Human Resources Officer



Joined 2014



Charlotta Persfell
Chief Marketing Officer



Joined 2023



Reetta Härkki
SVP & Chief Legal Officer



Joined 2008



Gerrit Schmidt
Interim President, Building
Solutions - Europe



Joined 2022

A large blue sign with the word "Uponor" in white, rounded letters. Below it, in smaller white letters, is "North American Headquarters". A man, seen from the back, is pointing at the sign. He has a tattoo of the word "Uponor" on his back. The sign is set against a dark background, possibly a building, with some greenery and flowers in the foreground.

Uponor

North American Headquarters

Leading PEX brand in North America



GF Uponor North America

2023 Q3 YTD Financial Results

\$407.7M

Net Sales

19.2%

OP-Margin



~4'500 SKU's

575M feet

Pipe production volume
2023 projected



875M feet

Max production
capacity

North America Headcount

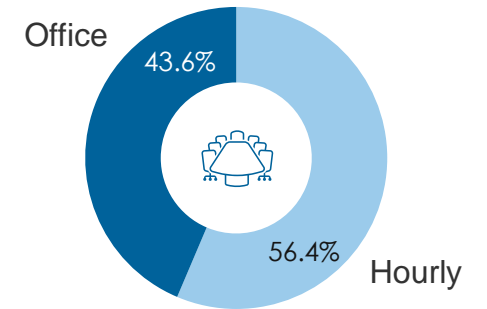

Sales by Country

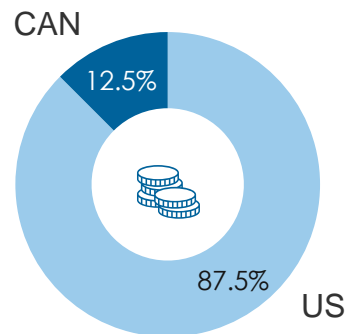

Product Mix

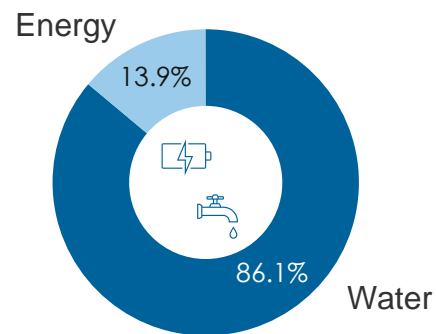

N.A. Footprint
1'041'132
sq. ft.

Renewable Electricity

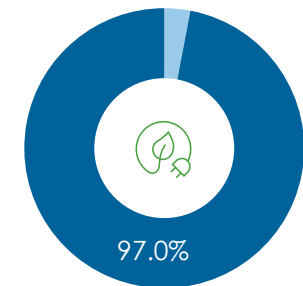



PEX improving productivity at job sites

Uponor PEX Benefits



Easier to use

No special flame training
No chemical handling



35% faster than PEX Crimp
49% faster than CPVC
79% faster than Copper

Uponor PEX market penetration



#1
PEX market leader
in North America



~1/3
Single-family residential homes
in NA built with Uponor pipe

Solving the labor shortage

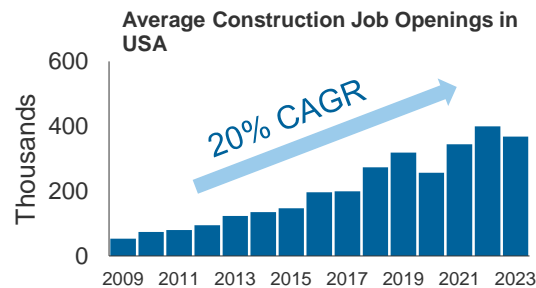

Price 1/5 Copper
Flat to CPVC



6.2%
Net sales CAGR
From 2017-2022

Material Share

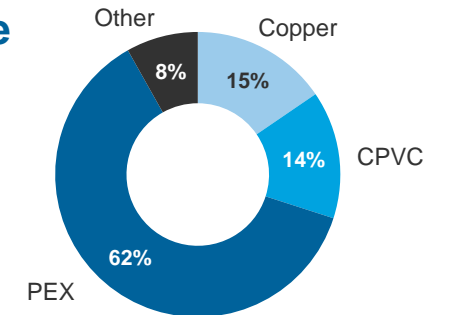

+ Expanding Capabilities

Manufacturing & Distribution

Geographical Expansion

Products & Technologies

uponor

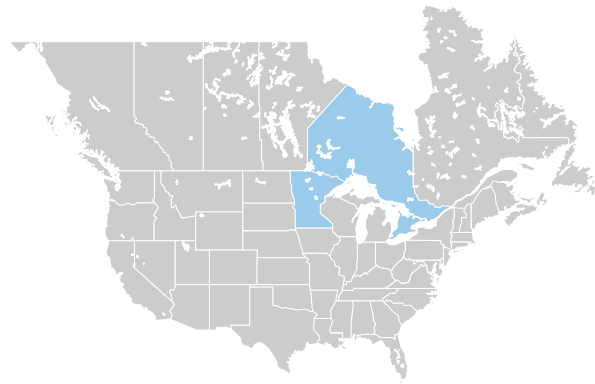

- USA
- Canada



Radiant Heating & Cooling



Energy Transport



Fire Safety



Hydronic Distribution



PEX & PP-RCT Plumbing Systems

+GF+
uponor

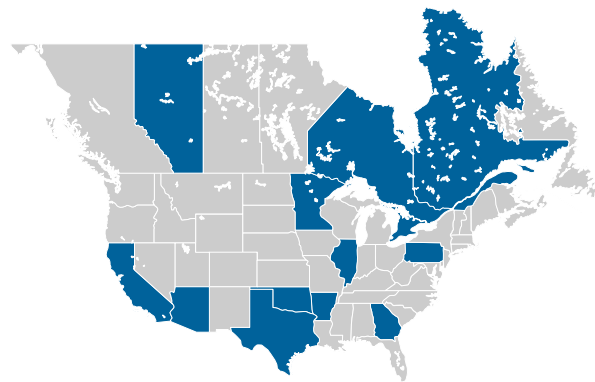

- USA
- Canada
- Mexico
- Brazil
- Argentina

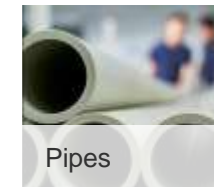

Pipes

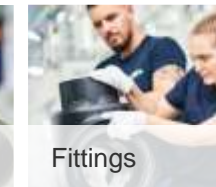

Fittings



Valves



Measurement & Control

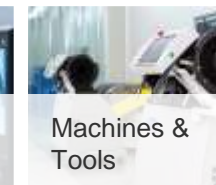

Machines & Tools



Specialized Solutions



Society Orlando mixed-use complex



Safe and clean water



Energy efficiency



Contributing to net zero

Orlando, Florida, USA

- Mixed-use apartments & office space
- 2023 **Project of the Year** (Plastics Pipe Institute)
- **Uponor AquaPEX[®]** for the domestic-water system providing efficient hot water delivery
- **Wirsbo hePEX[™]** for sustainable condenser-chilled water
- **Uponor PP-RCT** for large diameter condenser-chilled water



Demand for energy efficient systems



Climate change demands for energy efficient solutions in buildings

40%

of energy consumption in Europe caused by buildings ¹

60%

reduction of CO₂ emissions from buildings by 2030³



+100%

of CO₂ emissions expected to be caused by **cooling demand** over next 20 years²

ZERO

emissions from buildings by 2050³

“RENOVATION WAVE”
to double renovation rate

35 mio.

buildings to be renovated by 2030⁴



1 Figures from the United Nations Environment Program's Sustainable Buildings and Climate Initiative
2 Figures from a study by Ecofys ordered by Umweltbundesamt
3 According to press release of the European Parliament dated 9 Feb 2023
4 Figures from the European Council of an Energy-efficient Economy



Heating and cooling solutions powered by Smatrix technology for best comfort



Efficient heating and cooling with water-based floor and ceiling radiant solutions for smooth renovation



Uponor Smatrix Controls with innovative Autobalancing Technology, cloud-connected to selected energy sources



UP TO **30%**

reduction in energy consumption and CO₂ emissions¹



1. based on comparison Uponor radiant heating & cooling and Smatrix control combined with heat pumps or other alternative energy sources vs full air-based system for cooling and traditional gas boiler with high temperature radiators in winter, with on/off controls



Groundbreaking urban transformation project



Energy
efficiency

CO₂



Contributing
to net zero

Cartuja Qanat, Sevilla, Spain

- Building Type: Cultural institution
- Uponor Thermatop M Radiant Ceiling Cooling to ensure energy saving and comfort



Sustainable cooling in collaboration with Zaha Hadid architects



Energy efficiency

CO₂



Contributing to net zero

BEEAH Headquarters, Sharjah, UAE

- Building Type: Office building
- Most AI enabled office in the Middle East
- Energy-efficient cooling enabled by Uponor Ecoflex pipes
- Net-zero emissions building



Demand for safe and clean water



Water hygiene issues in buildings are one of the most underestimated challenges

3/4

of buildings in modern cities potentially have legionella problems¹

10-25%

rent reduction can be claimed by tenant in case of found legionella³



20'000

persons a year in Germany have health problems caused by legionella²

from 8'000 to 50'000 €

Is the average cost to get rid of legionella in a building⁴



Water must flow!



Do not store water!



Keep the right water temperature!



1. Gesundheitsamt Frankfurt. (2017). Infektionen, Infektionsprävention und Hygiene, p.148. | 2. Lück, C. (2010). Legionellen-Infektionen: Häufigkeit, mikrobiologische Diagnostik, Überwachung und Prävention. | 3. Court decisions on recent legal cases. | 4. Robert-Koch-Institut. (2016). Epidemiologisches Bulletin: Aktuelle Daten und Informationen zu Infektionskrankheiten und Public Health



Intelligent water flow systems ensure safe and clean drinking water at every point of use



Uponor Water Care

from components to system

up to 8x higher sales per dwelling compared to the sales of pipes and fittings

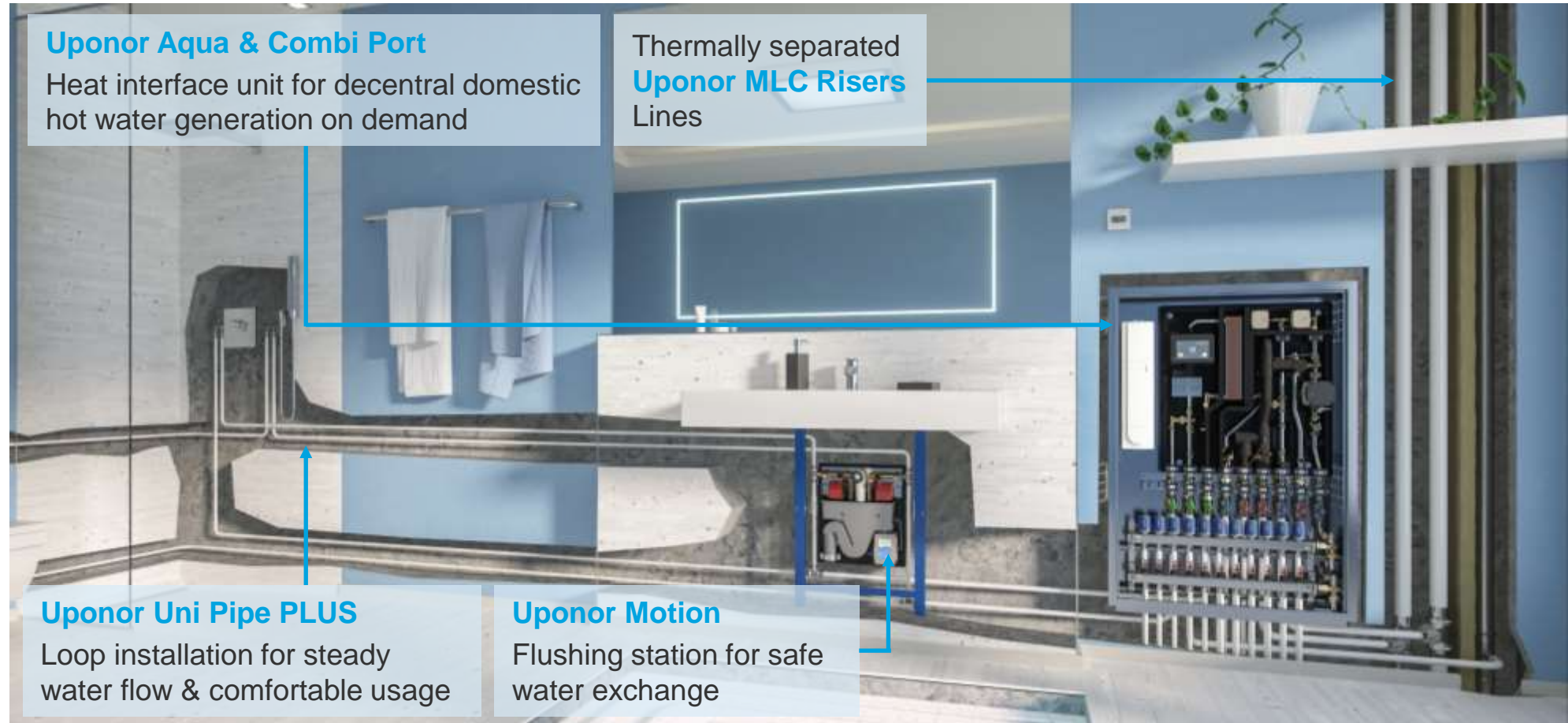

Uponor Aqua & Combi Port

Heat interface unit for decentral domestic hot water generation on demand

Thermally separated
Uponor MLC Risers Lines

Uponor Uni Pipe PLUS

Loop installation for steady water flow & comfortable usage

Uponor Motion

Flushing station for safe water exchange



Together we will offer solutions for both decentralized and centralized installations



Bathroom installation

+ GF Uponor
Hot and cold-water distribution
Decentralized solutions

+ GF Piping Systems
Hyclean system, riser installations
Centralized solutions



Decentralized heating and cooling distribution for one of Germany's tallest residential building



Safe and clean water



Energy efficiency



Contributing to net zero

Grand Tower, Frankfurt, Germany

- Building Type: Apartment building
- Size: 400 apartments and penthouses on 42 floors
- Equipped with [Uponor heat interface units](#) for decentral domestic hot water generation and radiant heating



GF Piping Systems in Switzerland ...



60

Sales employees

~30-35%

GF Building Technology
market share

Key customers





... will benefit from complete solutions for both water delivery and indoor climate ...

+GF+ uponor

Plumbing and Water Solution

Coral Force + Riser distribution + Valves

Hycleen + Drinking water installation



Domestic wastewater + Heat Interface Unit

Indoor Climate Solution

Local Heat Distribution + Manifolds + Controls

Radiant Heating & Cooling



... to increase the GF “share of wallet” per building





+GF+ uponor

An aerial photograph of a dense, vibrant green forest. A river winds through the trees, its surface reflecting the sky. The perspective is from directly above, showing the intricate patterns of the tree canopy and the meandering path of the water.

Wrap-up and Q&A



+GF+

uponor



Creating the next leader in the flow industry with sustainability and innovation at the core



Striving for **leadership**



Credible sustainability



Resilient portfolio



Innovation powerhouse



Global player



Platform for further growth



+GF+ uponor



+ Q&A

IR and Communication contacts

Investor Relations



Nadine Gruber

Head Investor Relations
+41 79 698 14 87
ir@georgfischer.com

Media Enquiries



Beat Römer

Head Corporate Communications
+41 79 290 04 00
media@georgfischer.com



Disclaimer

THE CONTENTS OF THIS PRESENTATION MAY NOT BE RELEASED, PUBLISHED OR DISTRIBUTED, IN WHOLE OR IN PART, DIRECTLY OR INDIRECTLY, IN OR INTO, AUSTRALIA, CANADA, HONG KONG, JAPAN, NEW ZEALAND OR SOUTH AFRICA OR IN ANY OTHER JURISDICTION IN WHICH THE TENDER OFFER WOULD BE PROHIBITED BY APPLICABLE LAW.

THIS PRESENTATION IS NOT A TENDER OFFER DOCUMENT AND AS SUCH DOES NOT CONSTITUTE AN OFFER OR INVITATION TO MAKE A SALES OFFER. IN PARTICULAR, THIS PRESENTATION IS NOT AN OFFER TO SELL OR THE SOLICITATION OF AN OFFER TO BUY ANY SECURITIES DESCRIBED HEREIN, AND IS NOT AN EXTENSION OF THE TENDER OFFER, IN, AUSTRALIA, CANADA, HONG KONG, JAPAN, NEW ZEALAND OR SOUTH AFRICA. INVESTORS SHALL ACCEPT THE TENDER OFFER FOR THE SHARES ONLY ON THE BASIS OF THE INFORMATION PROVIDED IN A TENDER OFFER DOCUMENT. OFFERS WILL NOT BE MADE DIRECTLY OR INDIRECTLY IN ANY JURISDICTION WHERE EITHER AN OFFER OR PARTICIPATION THEREIN IS PROHIBITED BY APPLICABLE LAW OR WHERE ANY TENDER OFFER DOCUMENT OR REGISTRATION OR OTHER REQUIREMENTS WOULD APPLY IN ADDITION TO THOSE UNDERTAKEN IN FINLAND.

THE TENDER OFFER IS NOT BEING MADE DIRECTLY OR INDIRECTLY IN ANY JURISDICTION WHERE PROHIBITED BY APPLICABLE LAW AND, WHEN PUBLISHED, THE TENDER OFFER DOCUMENT AND RELATED ACCEPTANCE FORMS WILL NOT AND MAY NOT BE DISTRIBUTED, FORWARDED OR TRANSMITTED INTO OR FROM ANY JURISDICTION WHERE PROHIBITED BY APPLICABLE LAWS OR REGULATIONS. IN PARTICULAR, THE TENDER OFFER IS NOT BEING MADE, DIRECTLY OR INDIRECTLY, IN OR INTO, OR BY USE OF THE POSTAL SERVICE OF, OR BY ANY MEANS OR INSTRUMENTALITY (INCLUDING, WITHOUT LIMITATION, FACSIMILE TRANSMISSION, TELEX, TELEPHONE OR THE INTERNET) OF INTERSTATE OR FOREIGN COMMERCE OF, OR ANY FACILITIES OF A NATIONAL SECURITIES EXCHANGE OF, AUSTRALIA, CANADA, HONG KONG, JAPAN, NEW ZEALAND OR SOUTH AFRICA. THE TENDER OFFER CANNOT BE ACCEPTED, DIRECTLY OR INDIRECTLY, BY ANY SUCH USE, MEANS OR INSTRUMENTALITY OR FROM WITHIN, AUSTRALIA, CANADA, HONG KONG, JAPAN, NEW ZEALAND OR SOUTH AFRICA AND ANY PURPORTED ACCEPTANCE OF THE TENDER OFFER RESULTING DIRECTLY OR INDIRECTLY FROM A VIOLATION OF THESE RESTRICTIONS WILL BE INVALID.

Not for release, publication or distribution in the United States, Canada, Australia or Japan

Information for Shareholders of Uponor in the United States

A voluntary public cash tender offer is being made by Georg Fischer Ltd. (the “Offeror”) to acquire all issued and outstanding shares in Uponor Corporation (the “Uponor”) (the “Shares”) (the “Tender Offer”), which is domiciled in Finland, and is subject to Finnish disclosure and procedural requirements. The Tender Offer is made in the United States in compliance with Section 14(e) of the U.S. Securities Exchange Act of 1934, as amended (the “Exchange Act”) and the applicable rules and regulations promulgated thereunder, including Regulation 14E (in each case subject to any exemptions or relief therefrom, if applicable) and otherwise in accordance with the disclosure and procedural requirements of Finnish law, including with respect to the Tender Offer timetable, settlement procedures, withdrawal, waiver of conditions and timing of payments, which are different from those of the United States. In particular, the financial information included in this presentation has been prepared in accordance with applicable accounting standards in Finland, which may not be comparable to the financial statements or financial information of U.S. companies. Shareholders in the United States are advised that the Shares are not listed on a U.S. securities exchange and that Uponor is not subject to the periodic reporting requirements of the Exchange Act, and is not required to, and does not, file any reports with the U.S. Securities and Exchange Commission (the “SEC”) thereunder.

The Tender Offer is made to Uponor’s shareholders resident in the United States on the same terms and conditions as those made to all other shareholders of Uponor to whom an offer is made. Any information documents are being disseminated to U.S. shareholders on a basis comparable to the method that such documents are provided to Uponor’s other shareholders.

To the extent permissible under applicable law or regulations, including Rule 14e-5 under the Exchange Act, the Offeror and its affiliates or its brokers and its broker’s affiliates (acting as agents for the Offeror or its affiliates, as applicable) may from time to time after the date hereof and during the pendency of the Tender Offer, and other than pursuant to the Tender Offer and combination, directly or indirectly, purchase or arrange to purchase the Shares or any securities that are convertible into, exchangeable for or exercisable for such Shares. These purchases may occur either in the open market at prevailing prices or in private transactions at negotiated prices. To the extent information about such purchases or arrangements to purchase is made public in Finland, such information will be disclosed by means of a stock exchange or press release or other means reasonably calculated to inform U.S. shareholders of Uponor of such information. In addition, the financial advisers to the Offeror may also engage in ordinary course trading activities in securities of Uponor, which may include purchases or arrangements to purchase such securities. To the extent required in Finland, any information about such purchases will be made public in Finland in the manner required by Finnish law.



Disclaimer

This publication constitutes neither an offer to sell nor a solicitation to buy securities of Georg Fischer AG or of any other company and it does not constitute a prospectus or similar notice within the meaning of articles 35 et seqq. or 69 of the Swiss Financial Services Act. Copies of this publication may not be sent to jurisdictions, or distributed in or sent from or otherwise made publicly available in jurisdictions, in which this is barred or prohibited by law. This publication constitutes advertising in accordance with article 68 of the Swiss Financial Services Act. Such advertisements are communications to investors aiming to draw their attention to financial instruments. Any investment decisions with respect to any securities should not be made based on this advertisement. This communication is being distributed only to, and is directed only at (i) persons outside the United Kingdom, (ii) persons who have professional experience in matters relating to investments falling within article 19(5) of the Financial Services and Markets Act 2000 (Financial Promotion) Order 2005 (the "Order") or (iii) high net worth entities, and other persons to whom it may otherwise lawfully be communicated, falling within Article 49(2) of the Order (all such persons together being referred to as "Relevant Persons"). Any investment or investment activity to which this communication relates is available only to Relevant Persons and will be engaged in only with Relevant Persons. Any person who is not a Relevant Person must not act or rely on this communication or any of its contents. This communication does not constitute an "offer of securities to the public" within the meaning of Regulation 2017/1129 of the European Union (the "Prospectus Regulation") of the securities referred to in it (the "Securities") in any member state of the European Economic Area (the "EEA") or, in the United Kingdom ("UK"), the Regulation (EU) 2017/1129 as it forms part of domestic law by virtue of the European Union (Withdrawal) Act 2018, as amended (the "UK Prospectus Regulation"). Any placements of the Securities to persons in the EEA or the UK will be made pursuant to an exemption under the Prospectus Regulation or the UK Prospectus Regulation (as applicable), as implemented in member states of the EEA or the UK, from the requirement to produce a prospectus for offers of the Securities. The securities referred to herein have not been and will not be registered under the US Securities Act of 1933, as amended (the "Securities Act"), and may not be offered or sold in the United States or to US persons (as such term is defined in Regulation S under the Securities Act) unless the securities are registered under the Securities Act, or an exemption from the registration requirements of the Securities Act is available. The issuer of the securities has not registered, and does not intend to register, any portion of the placements in the United States, and does not intend to conduct a public offer of securities in the United States. The securities are being offered and sold outside the United States in reliance on Regulation S and within the United States to "Qualified Institutional Buyers" (as defined in Rule 144A under the Securities Act ("Rule 144A")) in reliance on Rule 144A. Prospective purchasers are hereby notified that sellers of the Securities may be relying on the exemption from the provisions of Section 5 of the Securities Act provided by Rule 144A. This publication or the information contained therein is not being issued and may not be distributed in the United States of America, Canada, Australia, Japan or any other jurisdiction in which the distribution or release would be unlawful or require registration or any other measure and does not constitute an offer of securities for sale in such countries.

Opinions expressed herein reflect the current judgement of the management of GF. The presentation contains forward-looking statements that involve risks and uncertainties. The actual results of GF may differ materially from those anticipated in these forward-looking statements and forecasts as a result of a number of factors.

The management of GF does not accept any liability whatsoever with respect to the use of this presentation.



Disclaimer

This publication constitutes neither an offer to sell nor a solicitation to buy securities of Georg Fischer AG or of any other company and it does not constitute a prospectus or similar notice within the meaning of articles 35 et seqq. or 69 of the Swiss Financial Services Act. Copies of this publication may not be sent to jurisdictions, or distributed in or sent from or otherwise made publicly available in jurisdictions, in which this is barred or prohibited by law. This publication constitutes advertising in accordance with article 68 of the Swiss Financial Services Act. Such advertisements are communications to investors aiming to draw their attention to financial instruments. Any investment decisions with respect to any securities should not be made based on this advertisement. This communication is being distributed only to, and is directed only at (i) persons outside the United Kingdom, (ii) persons who have professional experience in matters relating to investments falling within article 19(5) of the Financial Services and Markets Act 2000 (Financial Promotion) Order 2005 (the "Order") or (iii) high net worth entities, and other persons to whom it may otherwise lawfully be communicated, falling within Article 49(2) of the Order (all such persons together being referred to as "Relevant Persons"). Any investment or investment activity to which this communication relates is available only to Relevant Persons and will be engaged in only with Relevant Persons. Any person who is not a Relevant Person must not act or rely on this communication or any of its contents. This communication does not constitute an "offer of securities to the public" within the meaning of Regulation 2017/1129 of the European Union (the "Prospectus Regulation") of the securities referred to in it (the "Securities") in any member state of the European Economic Area (the "EEA") or, in the United Kingdom ("UK"), the Regulation (EU) 2017/1129 as it forms part of domestic law by virtue of the European Union (Withdrawal) Act 2018, as amended (the "UK Prospectus Regulation"). Any placements of the Securities to persons in the EEA or the UK will be made pursuant to an exemption under the Prospectus Regulation or the UK Prospectus Regulation (as applicable), as implemented in member states of the EEA or the UK, from the requirement to produce a prospectus for offers of the Securities. The securities referred to herein have not been and will not be registered under the US Securities Act of 1933, as amended (the "Securities Act"), and may not be offered or sold in the United States or to US persons (as such term is defined in Regulation S under the Securities Act) unless the securities are registered under the Securities Act, or an exemption from the registration requirements of the Securities Act is available. The issuer of the securities has not registered, and does not intend to register, any portion of the placements in the United States, and does not intend to conduct a public offer of securities in the United States. The securities are being offered and sold outside the United States in reliance on Regulation S and within the United States to "Qualified Institutional Buyers" (as defined in Rule 144A under the Securities Act ("Rule 144A")) in reliance on Rule 144A. Prospective purchasers are hereby notified that sellers of the Securities may be relying on the exemption from the provisions of Section 5 of the Securities Act provided by Rule 144A. This publication or the information contained therein is not being issued and may not be distributed in the United States of America, Canada, Australia, Japan or any other jurisdiction in which the distribution or release would be unlawful or require registration or any other measure and does not constitute an offer of securities for sale in such countries.

Opinions expressed herein reflect the current judgement of the management of GF. The presentation contains forward-looking statements that involve risks and uncertainties. The actual results of GF may differ materially from those anticipated in these forward-looking statements and forecasts as a result of a number of factors.

The management of GF does not accept any liability whatsoever with respect to the use of this presentation.