



GF Corporation

Investor Presentation

April 2018



An industrial solution provider

We offer three times premium expertise and service to match our customers' needs:

GF Piping Systems



GF Casting Solutions



GF Machining Solutions



40%

CHF 1'678 million

36%

CHF 1'482 million

24%

CHF 992 million

Total sales in 2017: CHF 4'150 million

Growth well above target



- Sales up 11% at CHF 4'150 million
- Operating result increased 13% to CHF 352 million (CHF 311 million in 2016)
- Earnings per share reach CHF 62 (CHF 53 in 2016)
- Free cash flow (before acquisitions/divestments) at CHF 204 million
- Dividend increase to CHF 23 per share (CHF 20 in the previous year)

All three divisions grew sales significantly

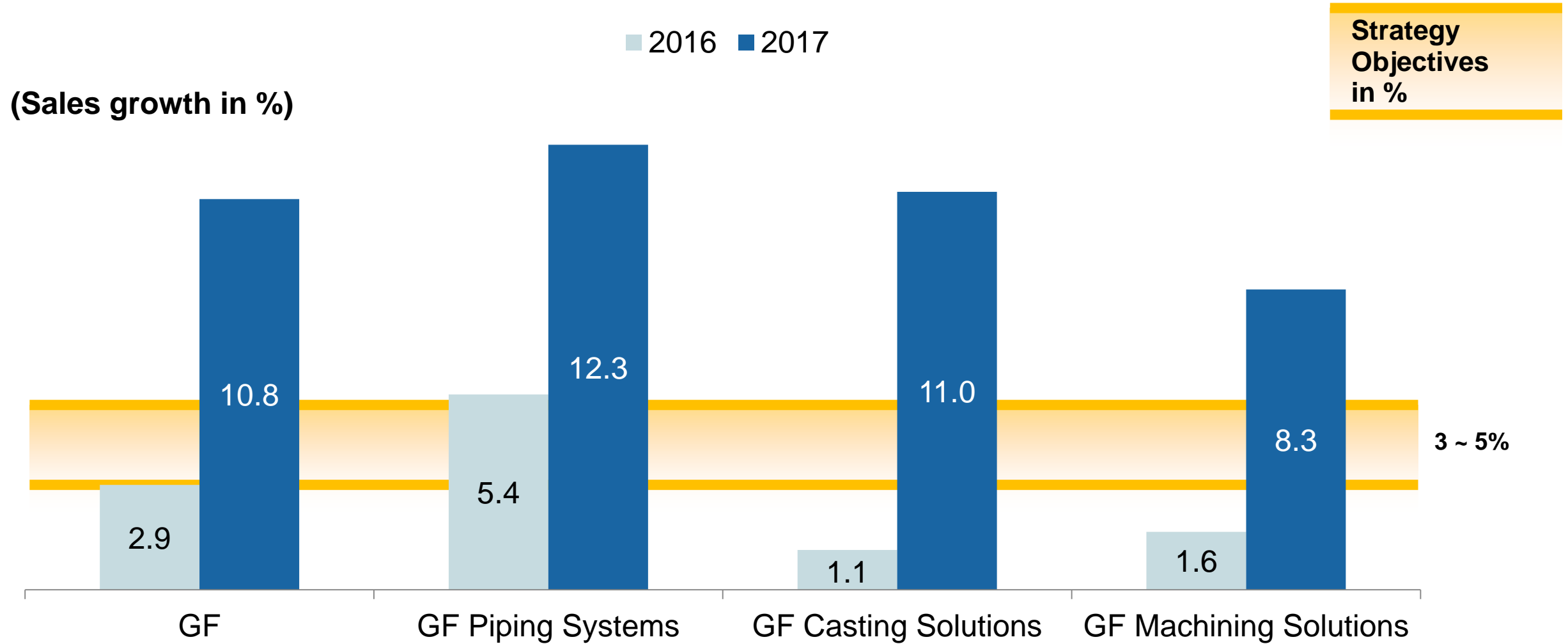

All three divisions in the strategic target range

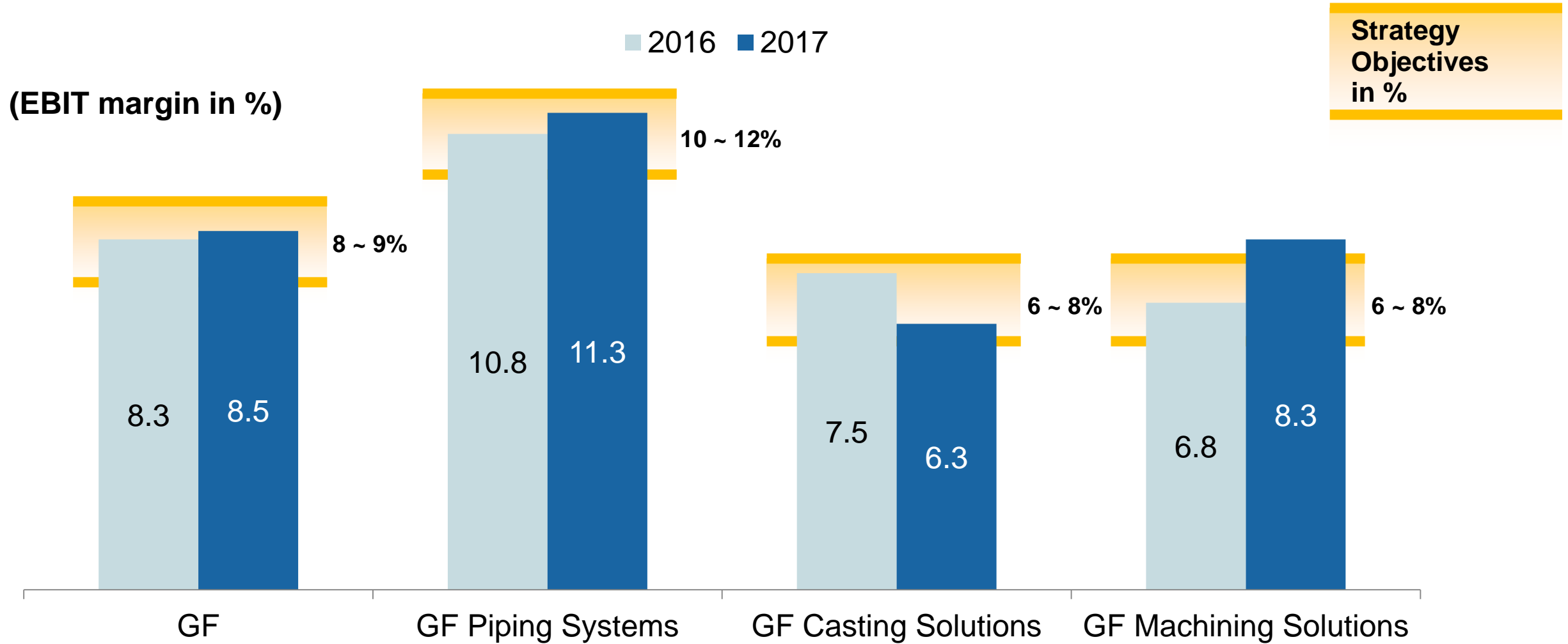

All three divisions again generate substantial value

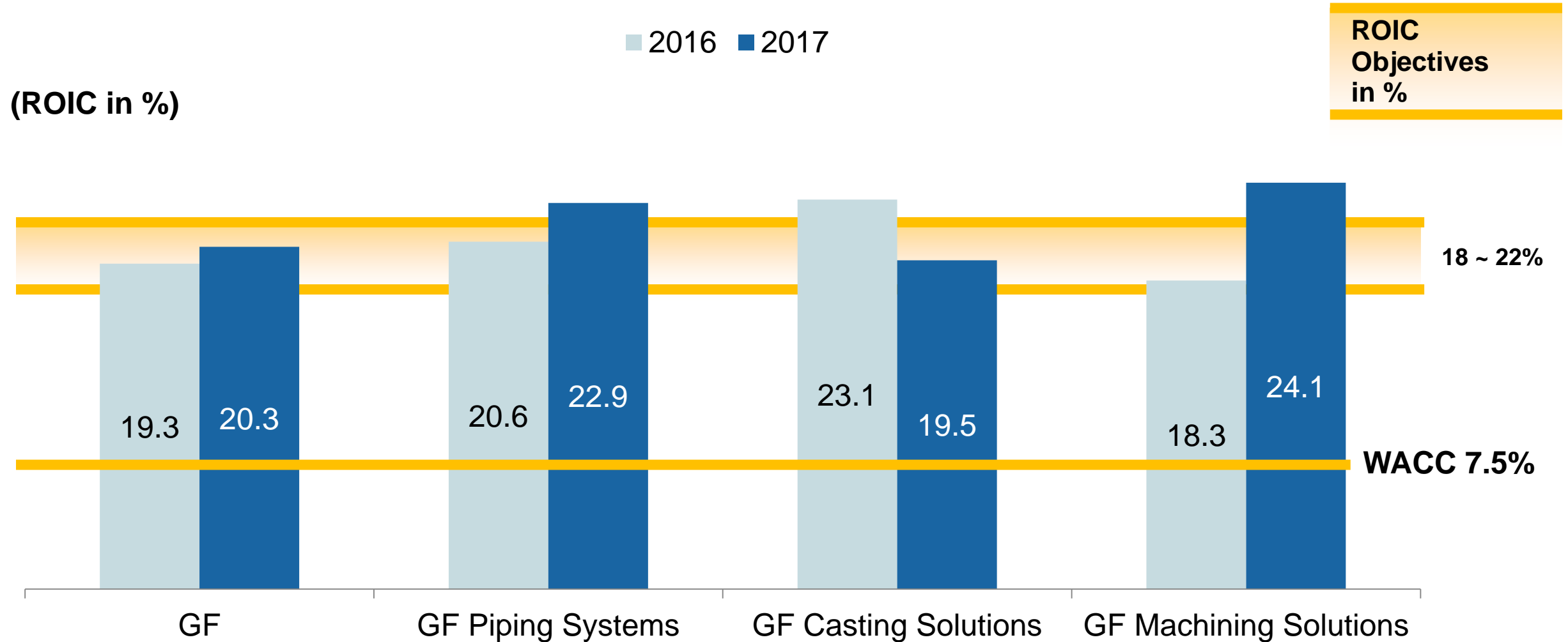

Strategy 2020 – Profitable expansion

- Widen presence in growth markets, optimize productivity in Europe
- Shift divisions' portfolio to higher margin businesses
- Drive sales proficiency and innovation excellence



Objectives

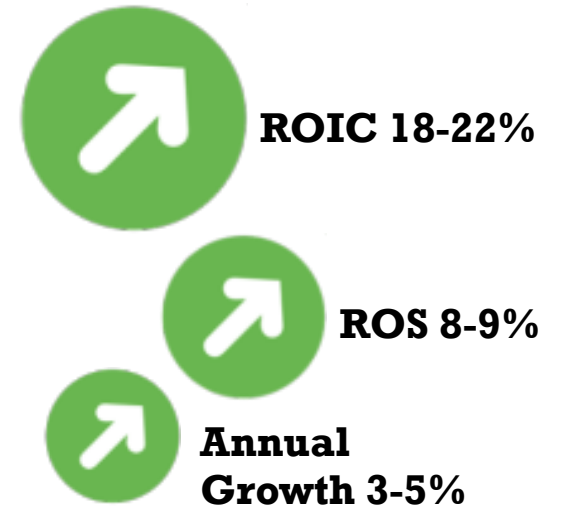

GF Piping Systems



GF Piping Systems Overview

- Complete systems for the safe transport of liquids and gases
- Pipes, fittings, valves, automation, jointing technologies, measurement & control
- For industry, utility and building technology



1'678

million (CHF) sales

6'764

employees

> 60

companies worldwide

Figures for 2017

GF Piping Systems Partnering with our customers ...

Utility



Gaz de France



Building Technology



Industry



... to conserve water and avoid contamination ...



... through safe and secure piping systems.

GF Piping Systems

Urecon acquisition as springboard for cooling in North America





GF Casting Solutions

GF Casting Solutions Overview



- Production of lightweight cast components and systems
- Made out of ductile iron, aluminum and magnesium
- For the global automotive industry and other industrial applications

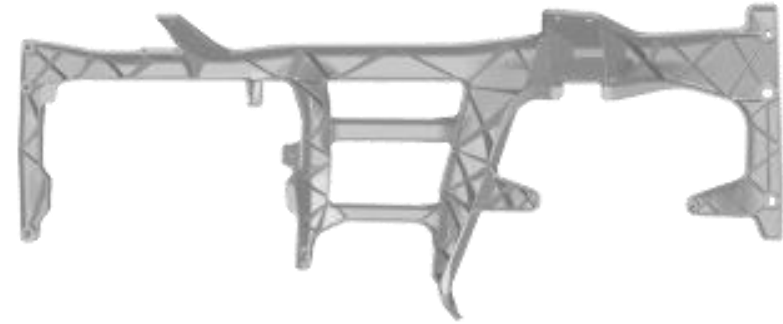

1'482

million (CHF) sales

5'738

employees

19

companies worldwide

Figures for 2017

Partnering with car/truck manufacturers worldwide ...



... to address the emission challenge ...



up to - 45 %



... through weight reduction.

High tempo expansion in light metal castings



Acquisition in Romania as base for Eastern Europe



High order book at new US plant GF Linamar



New mold production center in China

GF Casting Solutions

Ramp up of new production facility in North Carolina

GF Linamar Joint Venture



GF Machining Solutions



GF Machining Solutions Overview

- Machines and automation solutions for high precision manufacturing technologies
- EDM, milling and laser texturing
- For information and communication technology, aerospace and aeronautics, medical, dental etc.

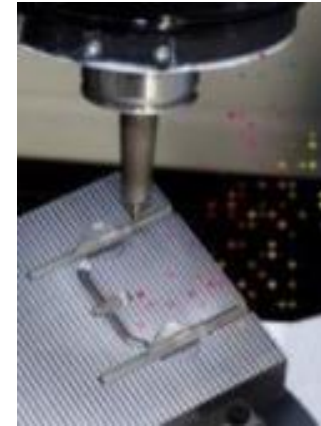

992

million (CHF) sales

3' 255

employees

36

companies worldwide

Figures for 2017

We offer our customers ...

ICT



Medical



Aviation



... solutions to their automated ...



... and connected precision needs...

We build the Internet
for Machines

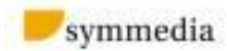

Remote Service

Easy and secure
connection
to the machine



Maintenance

Maintenance and
service management



Parts

Parts-shop
directly at the machine



Monitoring

Monitoring and
visualization
of machine statuses

Outlook 2018

- Strong momentum at GF Piping Systems
- Acquisitions/new capacities to support GF Casting Solutions growth
- High backlog at GF Machining Solutions

Further performance increase expected in line with our 2020 strategic goals

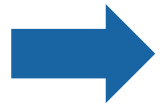

ROIC 18-22%
ROS 8-9%
Sales Growth 3-5%

Connected products ready for the market



Hycleen Automation System



Servicing machines with rConnect

GF Casting Solutions
Acquisition GF Precicast

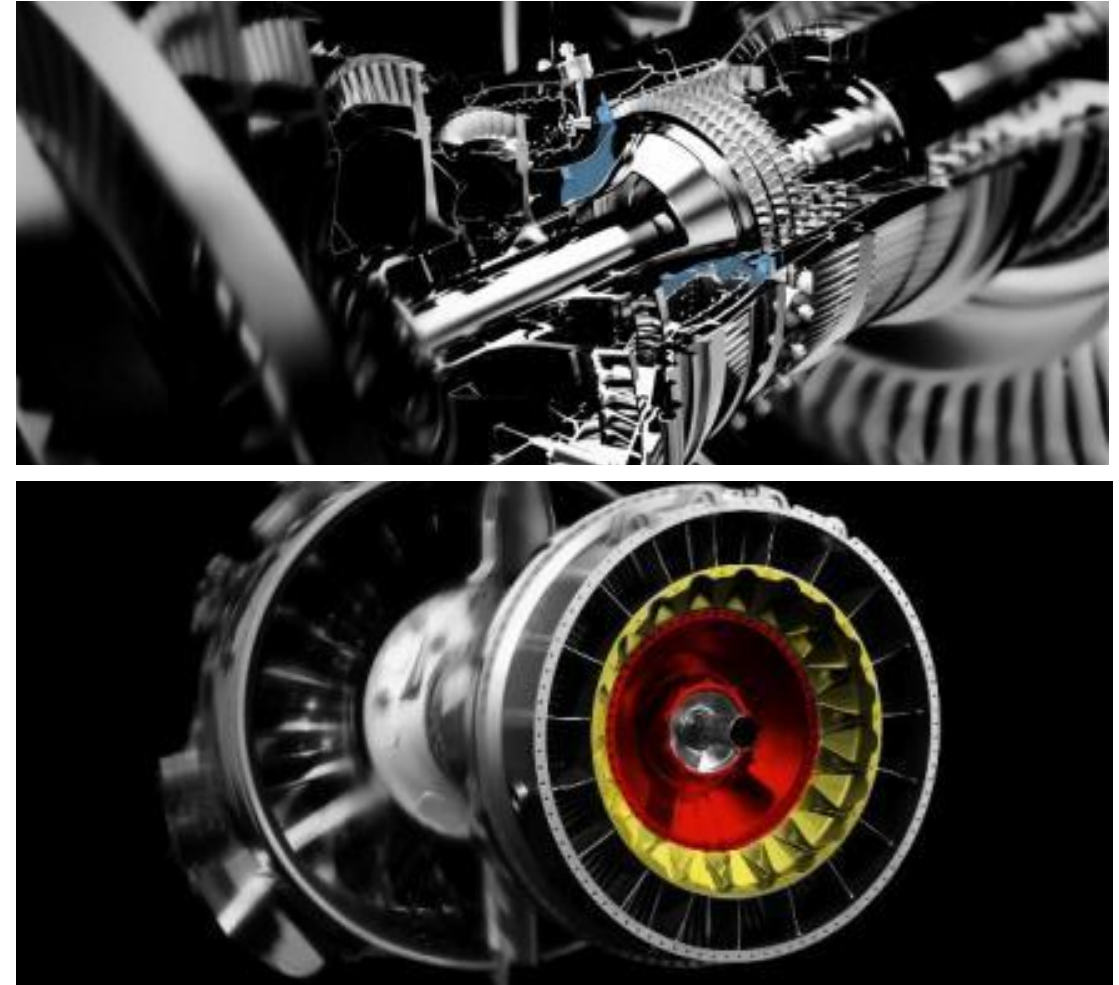

Precicast (Switzerland), investment casting specialist, signing 1/2018

Thank you



Disclaimer

This document is for presentation purposes only and should not be construed as an offer, invitation or solicitation to subscribe for, purchase or sell any investment. Neither it nor anything it contains shall form the basis of any contract whatsoever.

Opinions expressed herein reflect the current judgement of the management of GF. The presentation contains forward-looking statements that involve risks and uncertainties. The actual results of GF may differ materially from those anticipated in these forward-looking statements and forecasts as a result of a number of factors.

The management of GF does not accept any liability whatsoever with respect to the use of this presentation.

Backup Financials

Income statement



CHF million	2017	2016	Δ
Sales	4'150	3'744	11 %
Gross value added	1'539	1'421	8 %
Personnel expenses	-1'048	-978	7 %
EBITDA	491	443	11 %
Depreciation, amortization	-139	-132	5 %
EBIT	352	311	13 %
Financial result	-31	-31	-
Ordinary result	321	280	15 %
Non-operating result	1	1	-
Profit before taxes	322	281	15 %
Income taxes	-64	-56	14 %
Net profit	258	225	15 %
thereof own interests	252	216	17 %
thereof non-controlling interests	6	9	-33 %

Key figures at a glance



	2017	2016
Net debt in CHF	183	214
Net debt / EBITDA (multiple)	0.4x	0.5x
ROIC in %	20.3	19.3
Return on Equity in %	20.1	19.3
Earnings per share in CHF	62	53
Dividend per share in CHF	23	20
Number of employees (incl. trainees)	15'835	14'808

Backup Business Overview - Divisions

GF Piping Systems Business Overview

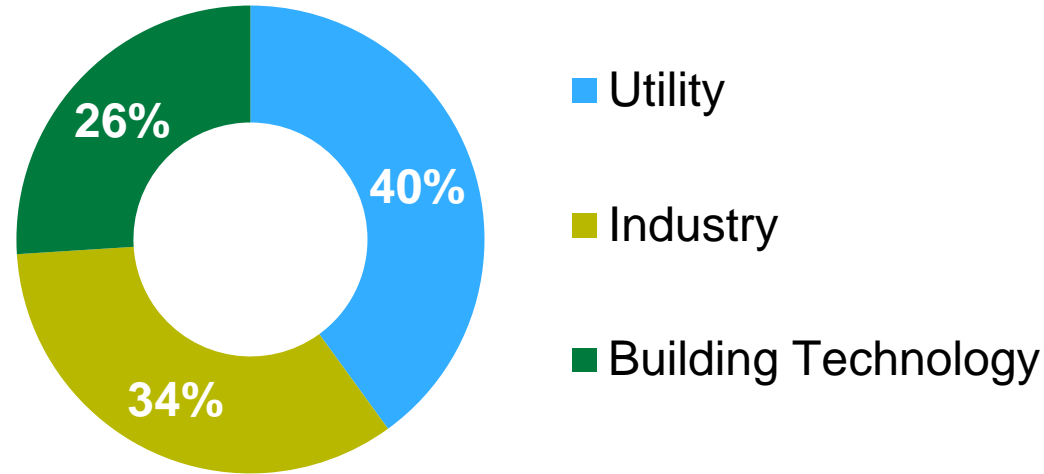

Utility

Market Trend:



Position: World #1 for PE electrofusion fittings

Major competitors: Aliaxis, Mexichem (Wavin), Agru

Industry

Market Trend:



Position: Market leader int.

Major competitors: Simona, Aliaxis, Spears, Watts Water, Sekisui, Asahi Yukizai

Building Technology

Market Trend:



Position: Switzerland #1, Leading in selected markets

Major competitors: Geberit, Uponor, Aalberts Ind, Rehau

GF Casting Solutions Business Overview

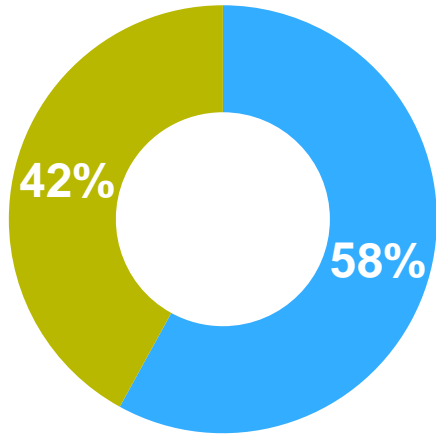

- Iron Castings
- Light Metal Castings

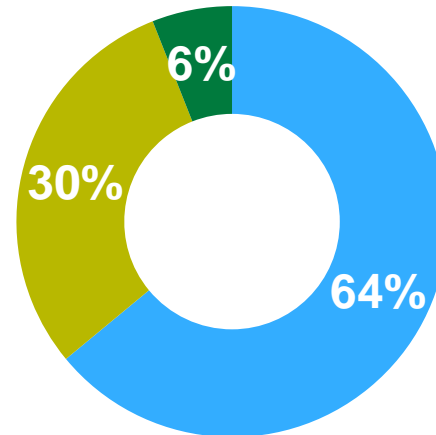

- Passenger Cars
- Trucks
- Industrial Applications

Iron Castings

Market Trend: 

Position: Europe #1

Major competitors:

Hitachi Metals, Fagor Ederlan, SLR, Walter Hundhausen, MeiTa, Halberg, Busch Hungaria

Light Metal Castings

Market Trend: 

Position: Europe Top 3

Major competitors:

Nemak, Ryobi, Martinrea, DGS, KSM Castings, Handtmann, Magna BDW

GF Machining Solutions Business Overview

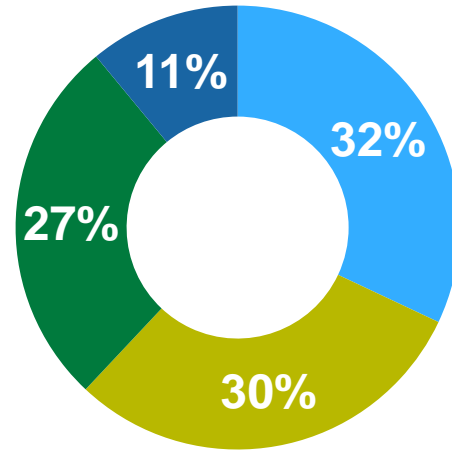

- Milling
- EDM
- Customer Services
- Automation/Tooling/Laser

Milling

Market Trend: 

Position: HSM Top 5

Major competitors:
Makino, Hermle, DMG
Mori, Rödgers, Exeron

EDM

Market Trend: 

Position: Top 3

Major competitors:
Sodick, Fanuc,
Mitsubishi, Makino

Customer Services

Market Trend: 

Position: #1
Coated Wire Sales

Automation/Tooling/Laser

Market Trend: 

Position: World #1

Major competitors:
Erowa, Hirschmann, F-Tool,
Zimmer & Kreim, Fastems

+GF+

